

# JVC

# Instructions

## MICRO HD CAMERA

# DZ-VCA1SE

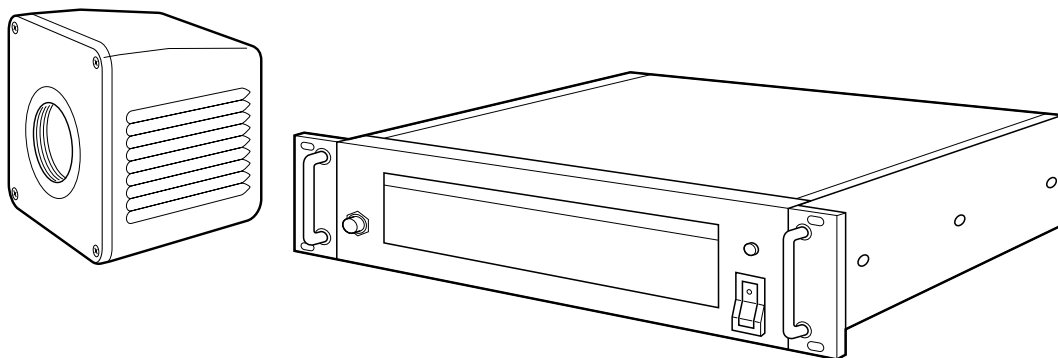

# CE

# Applications

---

Micro HD camera system can be used for following applications;  
(This system should only be operated by doctors or authorized persons.)

- (1) Operation microscope in OR  
neurosurgery, eye surgery, orthopedic surgery and etc.
- (2) Slit lamp microscope
- (3) Pathology microscope
- (4) Operation Room camera shooting operation area.
- (5) Endoscope operation in OR.

Above applications, the system can supply HD signals to HD monitor for display and to HD VTR for recording/play-back.

Also, by using SCSI I/F the system can supply digitized HD still picture to Zip drive for recording. Digitized still pictures in recorded removable disk can be stored into hard disc drive in PC.

## Dear Customer,

Thank you for purchasing the MICRO HD CAMERA. Before use, please read the safety information and precautions contained in the following pages to ensure safe use of your new MICRO HD CAMERA.

## Importer's name & address

**J.P.U.:** JVC PROFESSIONAL PRODUCTS (UK) LIMITED  
ULLswater House, Kendel Avenue, London W3 OXA, United Kingdom  
TEL: (0181) 896-6000  
FAX: (0181) 896-6060

**J.P.G.:** JVC PROFESSIONAL PRODUCTS GmbH  
Grüner Weg 10, 61169 Fiedberg/Hessen, Germany  
TEL: (06031) 6050  
FAX: (06031) 605180

# SOME DO'S AND DON'TS ON THE SAFE USE OF EQUIPMENT

---

This equipment has been designed and manufactured to meet international safety standards but, like any electrical equipment, care must be taken if you are to obtain the best results and safety is to be assured.

- DO** read the operating instructions before you attempt to use the equipment.
- DO** ensure that all electrical connections (including the mains plug, extension leads and interconnections between pieces of equipment) are properly made and in accordance with the manufacturer's instructions. Switch off and withdraw the mains plug when making or changing connections.
- DO** consult your dealer if you are ever in doubt about the installation, operation or safety of your equipment.
- DO** be careful with glass panels or doors on equipment.
- DON'T** continue to operate the equipment if you are in any doubt about it working normally, or if it is damaged in any way — switch off, withdraw the mains plug and consult your dealer.
- DON'T** remove any fixed cover as this may expose dangerous voltages.
- DON'T** leave equipment switched on when it is unattended unless it is specifically stated that it is designed for unattended operation or has a standby mode. Switch off using the switch on the equipment and make sure that your family knows how to do this. Special arrangements may need to be made for infirm or handicapped people.
- DON'T** use equipment such as personal stereos or radios so that you are distracted from the requirements of road safety. It is illegal to watch television whilst driving.
- DON'T** listen to headphones at high volume, as such use can permanently damage your hearing.
- DON'T** obstruct the ventilation of the equipment, for example with curtains or soft furnishings. Overheating will cause damage and shorten the life of the equipment.
- DON'T** use makeshift stands and NEVER fix legs with wood screws — to ensure complete safety always fit the manufacturer's approved stand or legs with the fixings provided according to the instructions.
- DON'T** allow electrical equipment to be exposed to rain or moisture.

### ABOVE ALL

- NEVER let anyone especially children push anything into holes, slots or any other opening in the case — this could result in a fatal electrical shock;
- NEVER guess or take chances with electrical equipment of any kind — it is better to be safe than sorry!

# Precautions on installing medical electrical equipment (Safety and hazard prevention)

For the safe use of this equipment, be absolutely sure to follow the guidelines below.

1. Leave installation of the Mobile Video Cart and the unit to a specially trained service man.
2. Be absolutely sure to use the separately sold AA-V31E isolation transformer and AC adapter AA-V112E.
3. There are openings in the equipment. Fire or electric shock may result if liquid splashes inside one of these openings. The front of the JVC-specified video cart has an opening. To prevent any possible problems, please set the cart in a reasonable position and use carefully. JVC cannot guarantee the total system when using an unspecified video cart.

## Cart information

Please use the VS5402.X or VS6300.X Mobile Video Cart to house the equipment.

- (1) Maximum load
  - Additional load: 225 kg
  - Monitor shelf: 35 kg
- (2) Front two casters have brakes.
  - When using mobile video cart, two brakes should be set for safety after setting the position of the cart.
- (3) Important notice 1
  - When using a mobile cart in OR, as the cart has no front cover, precautions to avoid splashing at front area of it should be taken.
  - When moving a mobile cart in OR, precautions to avoid crossing over the power cord of the cart.
  - When using a mobile cart in OR, precautions to avoid power cord of the cart to be caught by foot should be taken.
- (4) Important notice 2
  - When mounting monitor on a mobile cart, we strongly recommend the use of a monitor shelf and monitor strap for safety. (Refer to the following figure.)
- (5) Equipotential terminals are located inside the cart  
The back panel of the cart can be easily opened without any tool to gain access to the terminals.

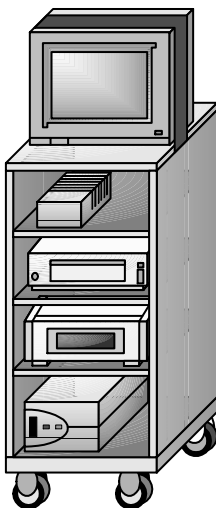

ex.) Mobile Video Cart VS5402.X

For medical use, please use the JVC Isolation Transformer, AA-V31E, and JVC AC Power Adapter, AA-V112E, in order to meet the following classifications.

- (1) Class 1 Equipment powered by an external electrical power source.
  - (2) Type BF Applied part (Degree of protection against electric shock)
- The specifications for the AA-V31E and AA-V112E are given on page 26.

# Safety precautions

## Please Read Before Use

**WARNING:**  
TO PREVENT FIRE OR SHOCK HAZARD, DO NOT EXPOSE THIS UNIT TO RAIN OR MOISTURE.

**CAUTION:**  
This MICRO HD CAMERA should be used with a power supply of AC 120 V  $\sim$ , 50 Hz only. To prevent electric shocks and fire hazards, DO NOT use any other power supply.

**WARNING:**  
This camera head, camera control unit, camera cable and video adapter are not sterilized.

**WARNING:**  
When using in an ENDOSCOPE application, to prevent fire or shock hazard, the equipotential terminals inside the video cart should be connected to the equipotential terminals of the isolation transformer and light source for the endoscope. Use the endoscope in accordance with IEC60601-1 and IEC60601-2-18.

**WARNING:**  
The use of ACCESSORY equipment not complying with the equivalent safety requirements of this equipment may lead to a reduced level of safety with the resulting system. Consideration relating to the choice of accessories shall include:

- use of the accessory in the vicinity of the patient
- evidence that the safety of the accessory has been certified in accordance with the appropriate IEC 60601-1 and/or IEC 60601-1-1 harmonized national standard.

**WARNING:**  
The HD Monitor requires an AC 120 V power supply. To prevent electric shock and fire hazard, DO NOT plug directly into a hospital wall outlet.

**WARNING:**  
In order to avoid the risk of fire and shock hazards, please use only the equipment specified in this instruction manual.

# Important product safety instructions

Electrical energy can perform many useful functions. But improper use can result in potential electrical shock or fire hazards. This product has been engineered and manufactured to assure your personal safety. In order not to defeat the built-in safeguards, observe the following basic rules for its installation, use and servicing.

## ATTENTION:

Follow and obey all warnings and instructions marked on your product and its operating instructions. For your safety, please read all the safety and operating instructions before you operate this product and keep this booklet for future reference.

## INSTALLATION AND DISPOSAL

### 1. Grounding or Polarization

Precautions should be taken so that the grounding or polarization of an appliance is not defeated.

### 2. Power Sources

Operate your product only from the type of power source indicated on the marking label. If you are not sure of the type of power supply to hospital, consult your product dealer or local power company. If your product is intended to operate from battery power, or other sources, refer to the operating instructions.

### 3. Overloading

Do not overload wall outlets, extension cords, or integral convenience receptacles as this can result in a risk of fire or electric shock.

### 4. Power Cord Protection

Power supply cords should be routed so that they are not likely to be walked on or pinched by items placed upon or against them, paying particular attention to cords at plugs, convenience receptacles, and the point where they exit from the product.

### 5. Ventilation

Slots and openings in the cabinet are provided for ventilation. To ensure reliable operation of the product and to protect it from overheating, these openings must not be blocked or covered.

- Do not block the openings by placing the product on a bed, sofa, rug or other similar surface.
- Do not place the product in a built-in installation such as a bookcase or rack unless proper ventilation is provided or the manufacturer's instructions have been adhered to.

### 6. Wall or Ceiling Mounting

The product should be mounted to a wall or ceiling only as recommended by the manufacturer.

### 7. Storage Location

Do not store this product in a humid location, such as near a window or an air conditioner, nor in a hot location, such as near a heater.

### 8. Disposing of the Product

Always sterilize this product before disposing of it. (See page 6.)

When discarding equipment, environmental problems must be considered and the local rules or laws governing the disposal must be followed strictly.

## FOR U.K. CUSTOMERS

If the socket outlets in hospitals are not suitable for the plug supplied with this appliance, it should be cut off and an appropriate 3 pin plug fitted. For details, refer to the instructions described below.

**Note:** The plug severed from the mains lead must be destroyed, as a plug with bared flexible cord is hazardous if engaged in a live socket outlet.

### Special Instructions for U.K. Model

#### IMPORTANT

THE WIRES IN MAINS LEAD ARE COLOURED IN ACCORDANCE WITH THE FOLLOWING CODE:

Blue: NEUTRAL

Brown: LIVE

As the colours of the wires in the mains lead of this apparatus may not correspond with the coloured markings identifying the terminals in your plug, proceed as follows: The wire which is coloured BLUE must be connected to the terminal which is marked with the letter N or coloured BLACK. The wire which is coloured BROWN must be connected to the terminal which is marked with the letter L or coloured RED. Making sure that neither core is connected to the earth terminal of the three pin plug.

## USE

### 1. Accessories

To avoid personal injury:

- Do not place this product on an unstable cart, stand, tripod, bracket, or table. It may fall, causing serious injury to a child or adult, and serious damage to the product.
- Use only with a cart, stand, tripod, bracket, or table recommended by the manufacturer or sold with the product.
- Use a mounting accessory recommended by the manufacturer and follow the manufacturer's instructions for any mounting of the product.
- Do not try to roll a cart with small casters across thresholds or deep-pile carpets.

### 2. Product and Cart Combination

A product and cart combination should be moved with care. Quick stops, excessive force, and uneven surfaces may cause the product and cart combination to overturn.

PORTABLE CART WARNING  
(Symbol provided by RETAC)



### 3. Water and Moisture

Do not use this product near water—for example, near a bath tub, wash bowl, kitchen sink or laundry tub, in a wet basement, or near a swimming pool and the like.

# Important product safety instructions (continued)

## 4. Object and Liquid Entry

Never push objects of any kind into this product through openings as they may touch dangerous voltage points or short-out parts that could result in a fire or electric shock. Never spill liquid of any kind on the product.

## 5. Attachments

Do not use attachments not recommended by the manufacturer of this product as they may cause hazards.

## 6. Cleaning

Unplug this product from the wall outlet before cleaning. Do not use liquid cleaners or aerosol cleaners. Use a damp cloth for cleaning.

## 7. Sterilization

Before using the endoscope, always be sure to sterilize the laparoscope video adapter, the HD camera head, and the camera cable.

## 8. Heat

The product should be situated away from heat sources such as radiators, heat registers, stoves, or other products (including amplifiers) that produce heat.

## SERVICING

### 1. Servicing

If your product is not operating correctly or exhibits a marked change in performance and you are unable to restore normal operation by following the detailed procedure in its operating instructions, do not attempt to service it yourself as opening or removing covers may expose you to dangerous voltage or other hazards. Refer all servicing to qualified service personnel.

### 2. Damage Requiring Service

Unplug this product from the wall outlet and refer servicing to qualified service personnel under the following conditions:

- a. When the power supply cord or plug is damaged.
- b. If liquid has been spilled, or objects have fallen into the product.
- c. If the product has been exposed to rain or water.
- d. If the product does not operate normally by following the operating instructions. Adjust only those controls that are covered by the operating instructions as an improper adjustment of other controls may result in damage and will often require extensive work by a qualified technician to restore the product to its normal operation.
- e. If the product has been dropped or damaged in any way.
- f. When the product exhibits a distinct change in performance—this indicates a need for service.

## 3. Replacement Parts

When replacement parts are required, be sure the service technician has used replacement parts specified by the manufacturer or have the same characteristics as the original part. Unauthorized substitutions may result in fire, electric shock or other hazards.

## 4. Safety Check

Upon completion of any service or repairs to this product, ask the service technician to perform safety checks to determine that the product is in safe operating condition.

## 5. Operational Life of the Product

Regular maintenance and inspection is essential for ensuring safe and long-lasting operation of this product. Inspect and maintain the product before and after use, and also have regular maintenance performed by a specialist.

### STERILIZATION:

The camera head with camera cable and video adapter can be sterilized with ethylene oxide (EO) and Sterad (50, 100, 100S, 500) supplied by Johnson & Johnson Medical Inc.

Ethylene oxide

Desorbition time for ethylene oxide after using aerator: more than 18 hours

Desorbition time is based on the following sterilization parameters:

Ethylene oxide gas : Ethylene oxide 20% and CO<sub>2</sub> 80%

Temperature : 40° to 60°C

Humidity : 40 to 60% RH

Ethylene oxide density : 500 to 600 mg/l

Desorbition method : Aeration

Aerator : 50°C and more than 18 hours  
(In room temperature it is required more than 48 H)

**Note:** Deterioration of camera cable

Due to ethylene oxide, rubber part of camera cable may cause deterioration.

Depending on the frequency of use, however at least once a year, an expert must check the device.

Sterad (H<sub>2</sub> O<sub>2</sub> plasma)

In the case of using Sterad, please follow the instruction of the manufacturer. Because of using Sterad many times, some cosmetic changes can be observed. However, the functions of HD camera system are not affected by those.

# Precautions

## Safety precautions

- Do not damage or modify the power cable. Doing so could result in current leakage or electric shock.
- To protect the camera and avoid electric shock hazards, always disconnect the power cord of the AC power adapter from the AC outlet when the camera is not in use for an extended period.
- Make sure that no flammable objects, water, or bits of metal get inside the unit. These could damage the unit or cause a malfunction.
- Whenever an anomaly (unusual noise, smell or smoke) occurs, immediately turn off the main unit's power, unplug the power cord, and consult your nearest JVC dealer.
- Never use digital equipment such as portable telephones or video cameras when using this unit as this may cause a malfunction.

## Handling precautions

- For extended product life, avoid using and storing the unit in places subject to the following conditions:
  - extreme heat or cold
  - vibrations
  - dust or soil
  - high humidity
  - strong noise source
- The environmental temperature under which this unit can be operated is limited by the image sensing device. Use this unit within an environmental temperature range of from +5°C to +35°C (41°F to 95°F).
- Avoid strong vibrations or violent shocks to this unit during installation or transportation.
- If the power voltage is too high or too low, the service life of this unit may be decreased and optimum performance may not be assured.
- Do not plug in or unplug the camera cable connector while this unit turned on. Doing so could cause a malfunction.
- Wipe the cabinet clean with a soft cloth. To remove excessive dirt, clean the unit with a soft cloth dipped in a mild detergent diluted with water. Wring out any excess liquid before wiping. Use a dry cloth to dry the unit. Do not use a volatile liquid such as benzene, thinner or alcohol. These may damage the cabinet surface or the coating.
- Be sure to use this unit in combination with the components described in "Micro HD camera system component list" on page 24. Do not use this unit near strong radio sources such as a radio, TV or portable phone, or near devices that produce a strong electromagnetic field such as a transformer or motor as this may generate noise in the picture or cause changes in image colour.
- Do not bring an electronic scalpel or other sources of electronic noise near this product. Doing so can interfere with the monitor display.
- When using a wireless microphone and receiver with this unit, check them beforehand to ensure that noise does not enter the wireless receiver.



If a problem develops concerning the operation of this product while it is being employed as an endoscopy system during surgery, etc., take the appropriate action as described below:

- Problem with the endoscope
  - The lamp for the light source may have been burned out. Please read the operating manual for details on replacing the lamp.
- Problem with the Micro HD Camera
  - If a problem with the operation of the monitor screen develops and the normal screen is no longer displayed, turn the power off and then turn the power back on again.
- Check the following items before using the product.
  - (1) Make sure that the product is grounded properly.
  - (2) Make sure that all of the cords are connected properly.
  - (3) When using this product in conjunction with other equipment, consult a specialist in order to minimize any risk of misoperation or misdiagnosis.
  - (4) Make sure that the product has been sterilized.
- Pay attention to the following while using the product.
  - (1) Make sure that the patient is not experiencing any distress.
  - (2) Make sure that all of the equipment is operating correctly.
  - (3) Make sure that the patient does not touch the product.
- Pay attention to the following after using the product.
  - (1) Following the prescribed procedure, return the product to its original state before it was used, and then turn the power off.
  - (2) When disconnecting the cords, do not pull on the cords with undue force.
  - (3) Storage location
    - Avoid locations where the product may get wet.
    - Avoid locations with extremes in air pressure, temperature, or humidity; poor ventilation; exposure to direct sunlight; high levels of dust; high levels of chlorine or sulfur compounds.
    - Avoid storing the product on an unstable surface; for example, one that is on a slope or is exposed to vibration or physical shocks.
    - Avoid storing the product in a location that is used to store chemicals or where gases are present.
- Clean the product, its accessories, and the cords so that they are ready for use the next time that they are needed.
- If the product malfunctions, do not attempt to repair it yourself. Place a label on it that clearly indicates that it is "out of order" and contact a repair specialist.
- Do not attempt to modify the product.
- Equipment not suitable for use in the presence of a flammable anaesthetic mixture with air or oxygen or nitrous oxide.

# Precautions (continued)

## Inspection and maintenance

- (1) The product and its components must be inspected regularly by a specialist. (The product should be inspected once every three times that it is used, or once every two months.)
- (2) When using the product after it has not been used for at least one month, confirm that the product still operates normally and safely before attempting to actually use it.

## Phenomena peculiar to CCDs

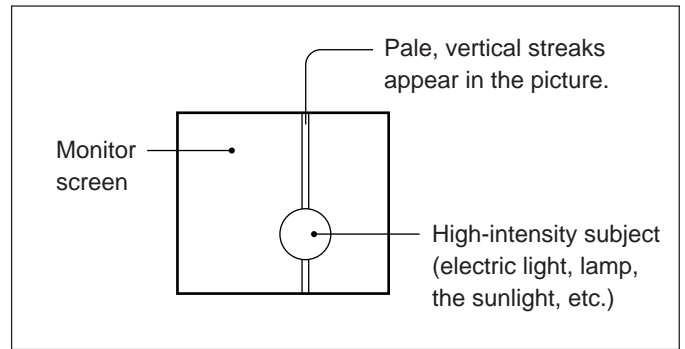

The following CCD-related phenomena may appear on the view screen during shooting. These are caused by the CCD and are not malfunctions.

### Smear phenomenon

Occurs when a high-intensity subject is shot.

### Aliasing distortion

Striped patterns or lines appear as jagged patterns.

### White or coloured luminescent spot

When this unit is operated for a long time under high temperature, a white or coloured luminescent spot may appear on the screen. In this case, it is necessary to lower the environmental operating temperature.

When a moving subject is shot, lines and patterns may appear jagged.

# Standard construction

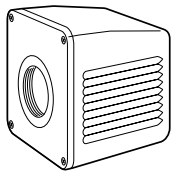

Camera head

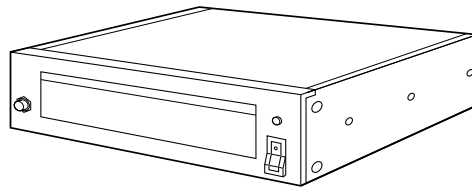

Camera control unit

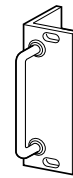

Handle x 2  
Screw x 8  
Washer x 4

Handle set

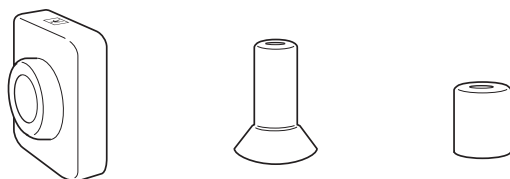

Insulating rubber covers x3



# Contents

Applications .....	2
Precautions on installing medical electrical equipment (Safety and hazard prevention) .....	3
Safety precautions .....	4
Important product safety instructions .....	5
Precautions	
Safety precautions .....	7
Handling precautions .....	7
Inspection and maintenance .....	8
Phenomena peculiar to CCDs .....	8
Standard construction .....	8
Features .....	9
Connections .....	11
Names of parts and their functions	
Camera control unit (front panel) .....	12
Camera control unit (rear panel) .....	13
Camera head .....	13
Gain control section .....	14
Shutter control section .....	15
White balance control section .....	16
Mode control section .....	17
Menu control section .....	18
Preparation	
Installing a lens .....	20
Installing the camera control unit .....	20
Before shooting	
Setting the switches for white balance adjustment .....	21
Back focus adjustment .....	21
Basic operation	
White balance adjustment (auto) .....	22
White balance adjustment (manual) .....	22
White balance adjustment (preset) .....	22
Connectors .....	23
Micro HD camera system component list .....	24
Specifications .....	25

# Features

Thank you for purchasing the  
**DZ-VCA1SE MICRO HD CAMERA.**

- **Compact, lightweight design**  
Thanks to the incorporation of 1/3-inch CCDs, the camera head's outer dimensions have been reduced to a compact 59 (W) x 70 (H) x 79 (D) mm and its weight to only 230 g.  
(1/3 the volume and 1/6 the weight of an ordinary HD camera) The CCU (camera control unit) can be mounted in a standard EIA 19-inch rack (2-unit size).
- **High resolution**  
A total of four NTSC 1/3-inch CCDs are used (2 for G and one each for R and B). Utilizing a newly-developed 4-CCD dual green system and digital signal processing, this camera is able to produce extremely high horizontal resolution of more than 800 TV lines and vertical resolution of more than 650 TV lines (approx. twice that of NTSC). The aspect ratio is 4:3.
- **System construction**  
HDTV studio standard (compliant with ITU-R Rec. 709) sync signals are used, allowing recorded picture to be played back with high picture quality when an HDTV VCR such as the W-VHS VCR is used.  
A cost-effective, high-picture-quality system can be configured using a multi-scan computer monitor.
- **Automatic sensitivity control**  
The automatic sensitivity control combines automatic sensitivity control with ALC and electronic iris (ALC + EEI) to allow trouble-free shooting under lighting conditions ranging from low to high intensity.
- **Electronic shutter function**  
A built-in 1/2000-sec. electronic shutter function allows capture and analysis of fast-moving subjects.
- **Flicker-free mode**  
Greatly reduces the flickering caused by shooting under a fluorescent lamp in locations using 50-Hz cycles.
- **Colour bar generator**  
A full colour bar generator is built in for easy system adjustment.
- **Switchable positive/negative signal**  
Signals can be inverted with a switch, allowing conversion of a negative film to a positive picture.
- **Automatic internal/external sync switching**  
Useful for systematic operations, such as multi-camera video processing, in combination with other devices.
- **2H contour provided as standard**  
Contour compensation is performed both horizontally and vertically to assure sharp, clear pictures.

• JVC cannot be responsible for any loss or damage to recorded material in the event that the colour video camera, VCR, or video cassette malfunctions during recording.

# Micro HD Camera System Configuration Diagram

**When connecting the camera to an endoscope**

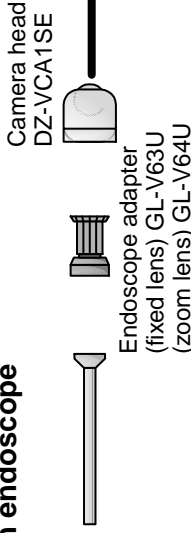

**When connecting the camera to an operation microscope**

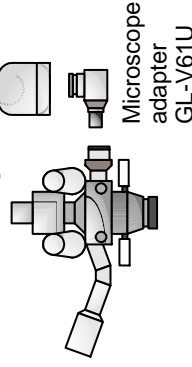

**When connecting the camera to a zoom lens**

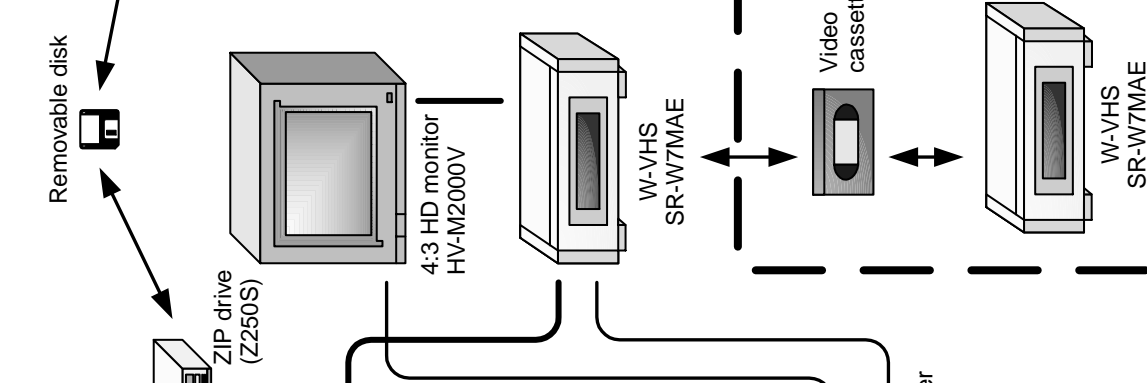
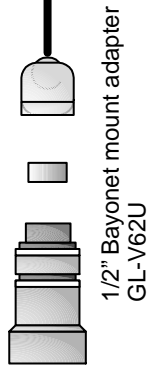

\* Before using the endoscope, always be sure to sterilize the endoscope video adapter, the camera head, and the camera cable.

Mobile video cart  
iTD GmbH VS5402.X or VS6300.X

## Outside the Operating Room

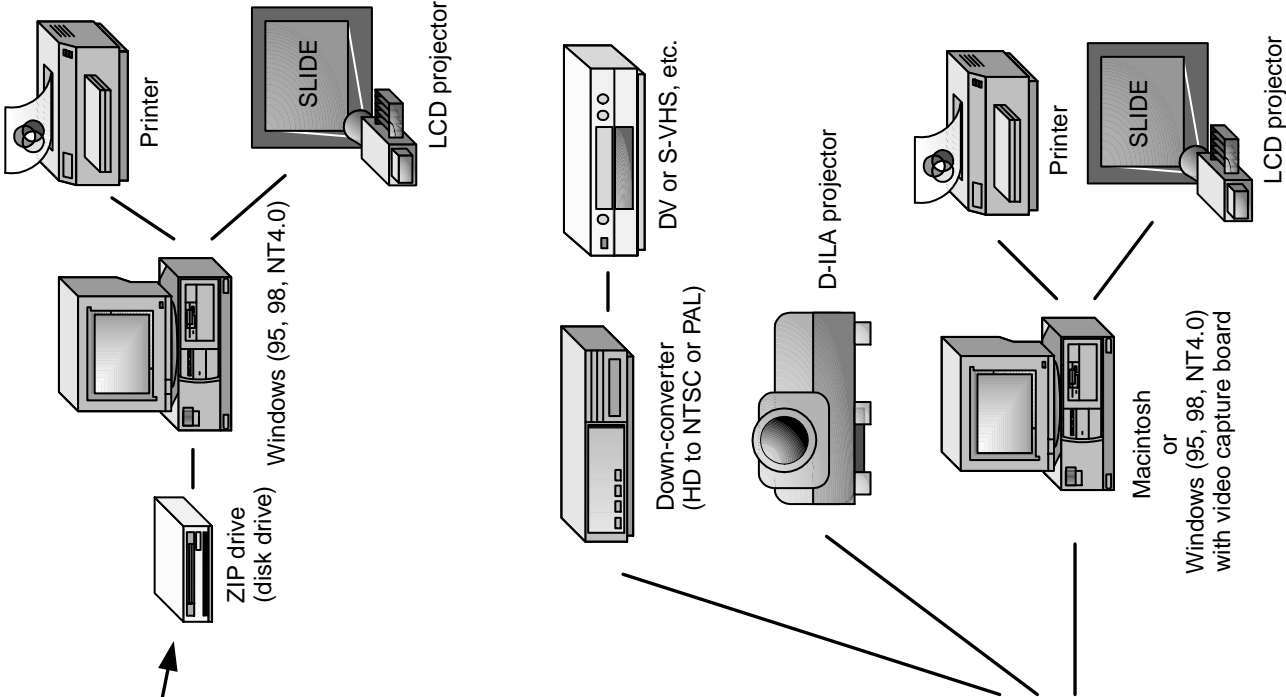

# Connections

## ■ Connection example

### Notes:

- Do not connect this camera to equipment other than that depicted in these connection diagrams.
- Always be certain to use the AA-V31E Isolation Transformer.

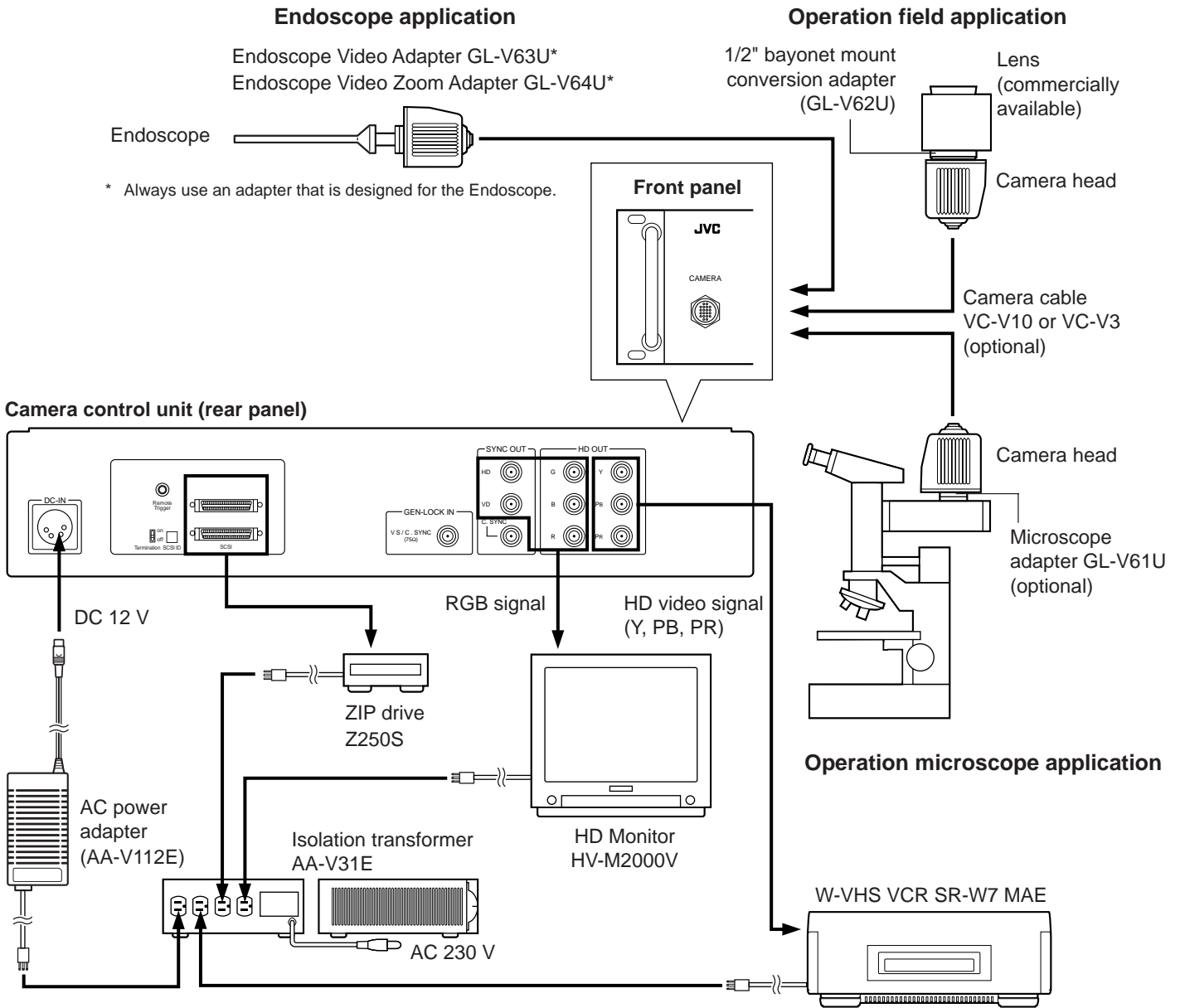

- The camera head and camera control unit are adjusted as a set. Be sure the serial numbers match. Optimum picture quality may not be obtained if a different combination is used.
- When the system is connected, check that current leakage from this connection does not surpass the specified level. Also, be absolutely sure to use an AA-V31E isolation transformer.
- If the exterior of the isolation transformer is corroded, inadequate grounding may result. Have the exterior replaced by your local JVC dealer.

# Names of parts and their functions

## Camera control unit (front panel)

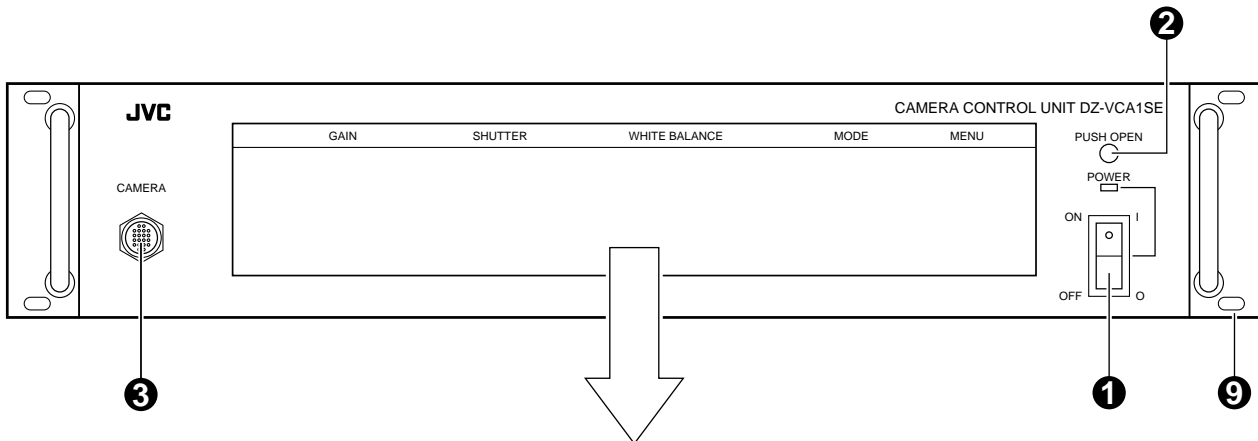

### Interior of the function box

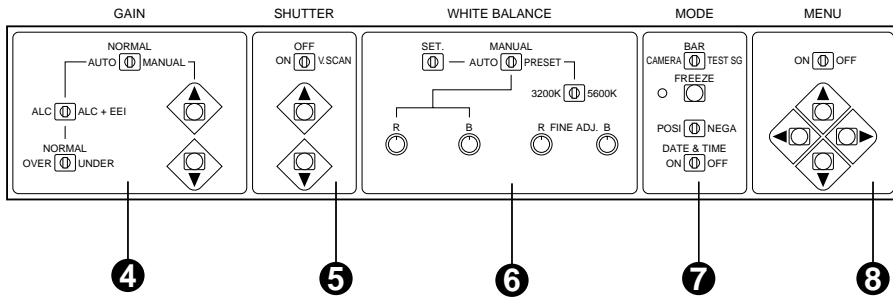

#### 1 [POWER] power switch and power indication LED

#### 2 [PUSH OPEN] door button

Press to open the function box.

#### 3 [CAMERA] camera cable connector

Connect to the camera head using the optional camera cable.

#### 4 Gain control section

Set for automatic or manual gain adjustment. Set the automatic adjustment combining the gain and shutter.

#### 5 Shutter control section

Set the shutter speed of the electronic shutter. When [ALC+EEI] is set in the gain control section, the setting operation for the shutter control section is disabled.

#### 6 White balance control section

Adjust the white balance automatically or manually. Perform the fine adjustment for red or blue.

#### 7 Mode control section

Switch the signal output to the monitor among camera, colour bar and 100% white. Also, switch between the negative and positive or select whether or not the date and time is displayed.

#### 8 Menu control section

Display the menu to carry out various settings.

#### 9 Handle (provided)

Use the screws and washers provided to secure the handle to the Camera Control Unit.

**Note:** Be sure to attach the handle securely so that you do not accidentally drop the unit.

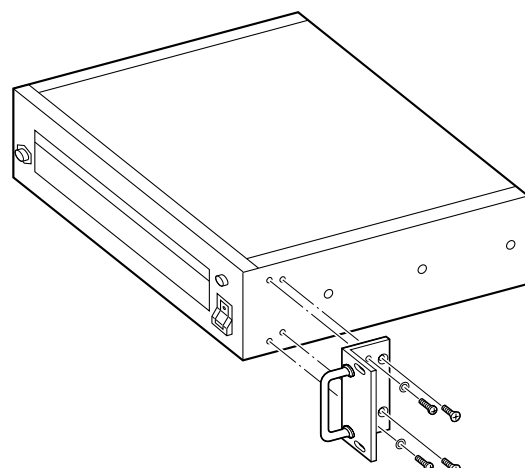

Handle installation

## Camera control unit (rear panel)

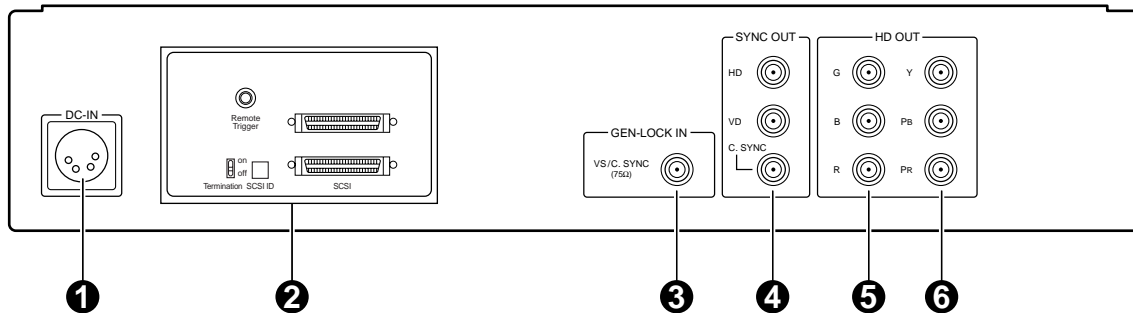

### 1 [DC INPUT] DC input connector

Input DC 12 V from the optional AA-V112E power adaptor.

### 2 Cover for extension slot

Remove the cover to install an optional device in this slot.

For the SCSI interface, refer to the instruction books for the "Hardware" or "Driver Software".

### 3 [GENLOCK INPUT] external sync signal input jack

Reference signal input jack used to connect the camera video output signal in sync with other equipment such as an HD camera and switcher.

### 4 [SYNC OUT] sync signal output jacks

Outputs HD (horizontal drive signal)/VD (vertical drive signal)/C. SYNC.

### 5 [RGB OUT] RGB signal output jacks

Outputs RGB signals.

### 6 [Y, P<sub>B</sub>, P<sub>R</sub> OUT] video signal output jacks

Output Y, P<sub>B</sub>, P<sub>R</sub> signals.

When video signals are output to an HDTV monitor, the screen will have a 16:9 aspect ratio, resulting in a horizontally extended picture.

## Camera head

(Front view)

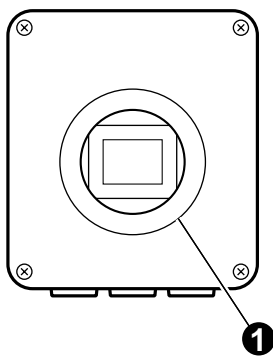

(Side view)

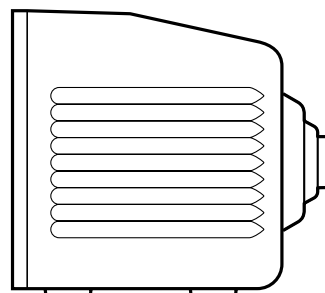

(Rear view)

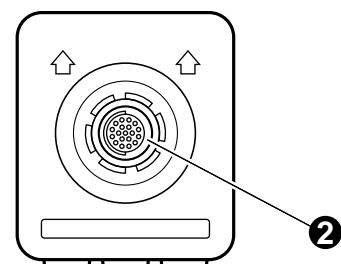

### 1 Lens mount ring

- A special C mount is used. The form is for C mount, however, the flange back length is 28.0 mm.

Ordinary C mount cannot be used.

The flange back length of an ordinary C mount conversion lens is 17.526 mm.

- To install a 1/2-inch bayonet mount conversion lens, use the optional 1/2-inch bayonet mount conversion adapter (GL-V62U).

### 2 Camera cable connector

Connect the camera control unit with the optional camera cable.

# Names of parts and their functions (continued)

## Gain control section

### 1 GAIN switch

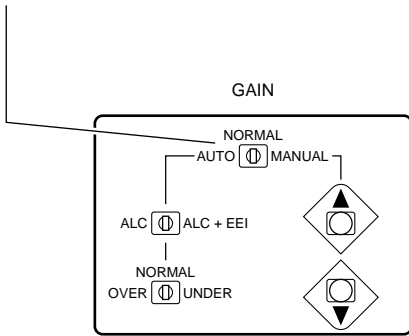

### 2 AUTO MODE switch

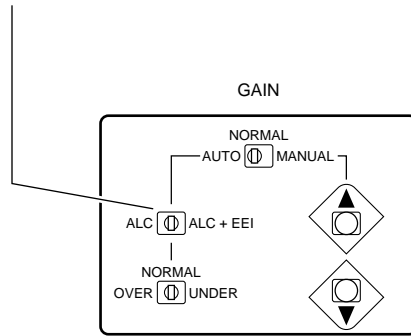

#### [AUTO]

The modes set with the 2 [AUTO MODE] switch can be engaged for automatic gain adjustment. In this mode, the [GAIN UP]/[GAIN DOWN] buttons are disabled.

#### [NORMAL]

Sets the gain to the reference gain [0 dB].

#### [MANUAL]

Select this mode to set the gain manually with the [GAIN UP] and [GAIN DOWN] buttons.

#### [ALC]

Adjusts the gain automatically according to changes in the brightness of the subject (auto sensitivity adjustment).

#### [ALC + EEI]

Automatically adjusts exposure by adjusting the gain and shutter speed in combination according to changes in the brightness of the subject.

### 3 AUTO GAIN switch

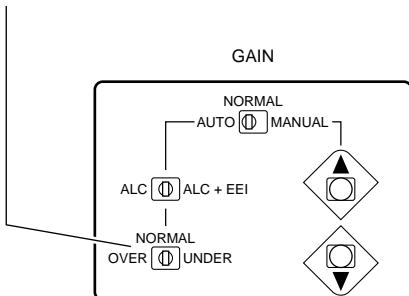

The [NORMAL] position is for standard auto sensitivity adjustment. The [OVER] position adjusts the gain for more brightness while the [UNDER] position adjusts the gain for less brightness.

Effective only when the [GAIN] switch 1 is set to [AUTO].

### 4 GAIN UP/GAIN DOWN buttons

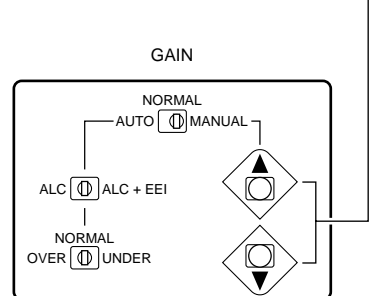

#### [GAIN UP]

Each time this button is pressed, the gain increases by 1 dB.

#### [GAIN DOWN]

Each time this button is pressed, the gain decreases by 1 dB.

Effective only when the [GAIN] switch 1 is set to [MANUAL]. Setting from -3 dB to +12 dB is possible.

## Shutter control section

### ① SHUTTER switch

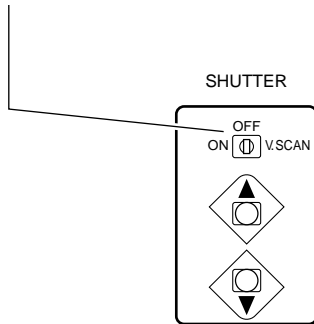

### ② SHUTTER UP/DOWN buttons

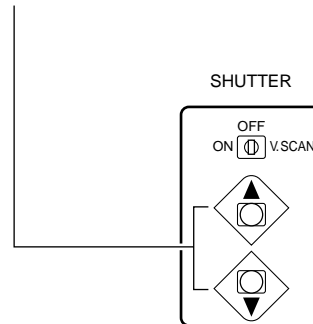

### SHUTTER switch ① and SHUTTER [UP]/[DOWN] buttons ②

- When the SHUTTER switch ① is set to [ON]
  - Press the SHUTTER [UP] button ② to decrease the shutter speed.
  - Press the SHUTTER [DOWN] button ② to increase the shutter speed.
 Shutter speeds from 1/2000 to 1/30 sec. are available.

Usually shutter speed is not stored. If you want to store it, set the shutter speed and then, switch a cycle of change from [ON] to [OFF] of the ① MENU switch on page 16 in spite of the initial position.

- When the SHUTTER switch ① is set to [OFF]
 

The shutter speed is fixed at 1/60 sec.
- When the SHUTTER switch ① is set to [V. SCAN]
 

Set the shutter speed to match the scanning speed of a computer monitor. When shooting a monitor, fine-adjust the shutter speed to eliminate bright and dark bars running horizontally. When the shutter speed is faster than 1/60 sec., it is possible to fine adjust it with the SHUTTER [UP]/[DOWN] buttons ②.

When the SHUTTER switch ① is set to [OFF] or the gain control section is set to [ALC+EEI], the SHUTTER [UP]/[DOWN] buttons ② have no effect.

### Flicker-free mode

Prevents flickering caused by fluorescent lighting in a 50-Hz area.

When the shutter speed is set to 1/100 sec. (Flicker-free mode), flickering is eliminated.

- When looking at the picture on the monitor during the use of the electronic shutter, the movement of the subject may appear discontinuous. This phenomenon occurs because the picture for 1/2000 sec. is taken out every 1/60 sec. (e.g.: Shutter speed of 1/2000 sec.)
- When the shutter speed is set to 1/2000 sec., the charge storage time of the CCD image sensing device is reduced to approx. 1/32. As a result, the sensitivity is 1/32 that for the ordinary normal mode (1/60 sec.) and the light is insufficient. When shooting, increase the illumination by a factor of 32 or open the lens iris by 5 if sufficient light is available to obtain the optimum exposure.
- As the shutter speed in the V. SCAN mode is not displayed, set the speed by viewing the picture so that a stable picture can be obtained.

### At-a-glance sensitivity range chart (relationship between gain, iris value and shutter)

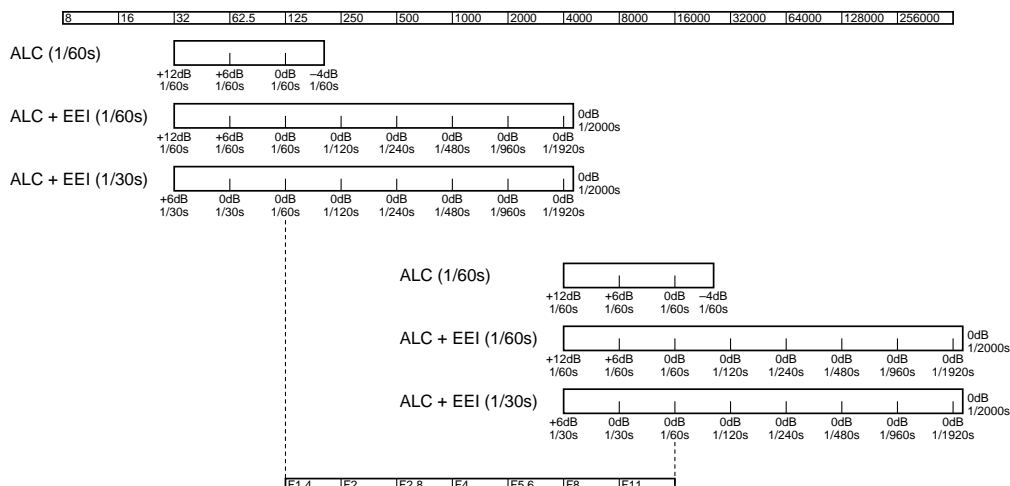

# Names of parts and their functions (continued)

## White balance control section

### 1 WHITE BALANCE switch

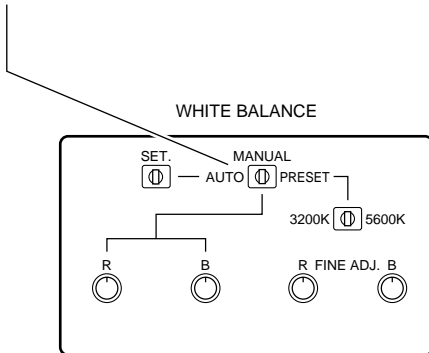

#### [AUTO]

When set to this position, the camera is automatically set to a pre-adjusted white balance.

Use the [SET] switch 2 to automatically readjust the white balance.

#### [MANUAL]

Set to this position to adjust the white balance manually with the [R]/[B] volume controls 3.

#### [PRESET]

Set to this position to set the white balance adjusted using 3200K and 5600K light sources or the white balance preset by a technician.

3200K and 5600K can be switched with the [3200K/5600K] switch 4.

### 2 SET switch

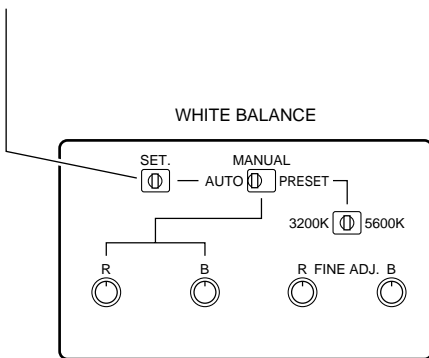

- If white balance adjustment has not been performed, adjust it by referring to the "Basic operation".
- In all [AUTO] and [PRESET] modes, red and blue can be fine-adjusted with the [ADJ R] and [ADJ B] volume controls 5 for FINE ADJ.

### 3 R/B volume controls

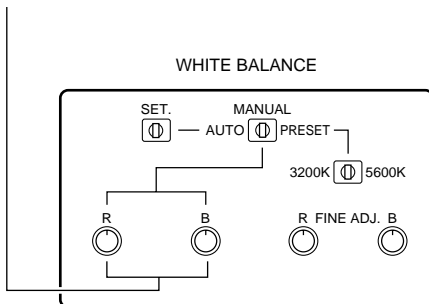

### 4 3200K/5600K switch

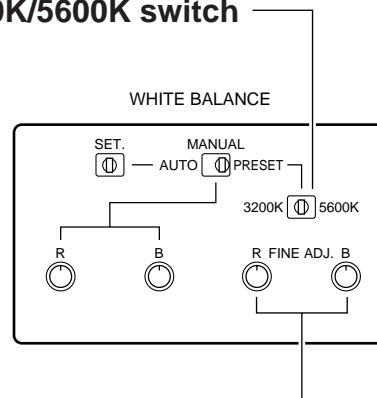

### 5 ADJ R/ADJ B volume controls



## Mode control section

### ① SOURCE switch

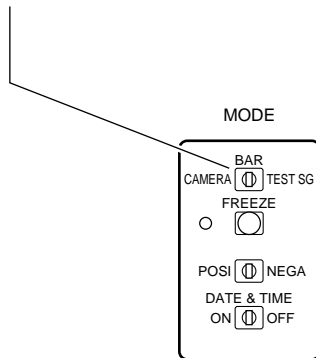

#### [CAMERA]

Outputs signals from the camera to the monitor.

#### [BAR]

Outputs an internal colour bar signal from the unit to the monitor.

#### [TEST SG]

Outputs an internal 100% WHITE square screen from the unit to the monitor.  
Use to adjust for 100% WHITE and the aspect ratio of the monitor.

### ② FREEZE button

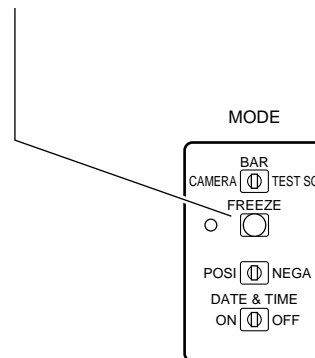

Press the FREEZE button to engage the Field Still mode and press it again to restore the normal mode.  
The status is shown by the LED at the left of the FREEZE button.

LED lit : Field still

LED extinguished : Normal use

### ③ POSI/NEGA switch

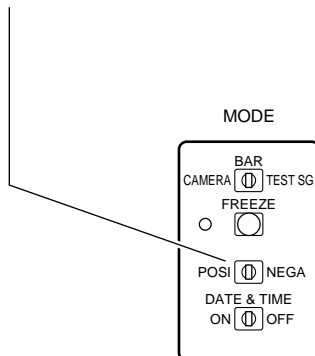

#### [POSI]

Set to this position for ordinary operation.

#### [NEGA]

Outputs inverted red, blue and green signals from the camera to the monitor.

### ④ DATE & TIME switch

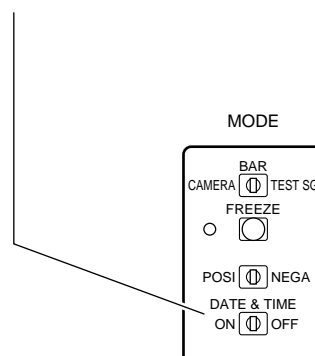

#### [ON]

The date and time are shown in the upper right corner of the screen.

#### [OFF]

The date and time are not shown.

# Names of parts and their functions (continued)

## Menu control section

### ① MENU switch

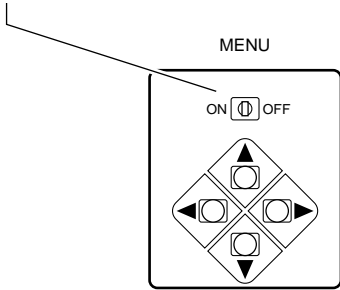

**[ON]**  
The menu is displayed on the screen.  
Select a menu item with the CURSOR button ②.

**[OFF]**  
The menu is not displayed.

Menu settings will be stored in memory when this switch is set to [OFF]. When you finish menu setting, be sure to set this button to [OFF] before turning the power off.

### ② CURSOR button

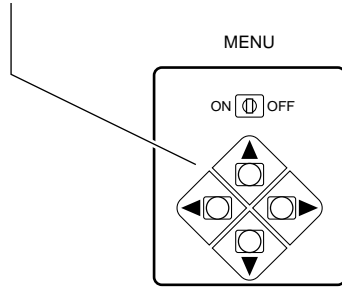

- The mark (•) on the left of the menu item indicates that the item is selected.
- An up arrow (↑) or down arrow (↓) on the left of a menu item indicates that items can be selected with the [UP]/[DOWN] CURSOR buttons ②.
- A right arrow (→) or left arrow (←) on the right of a menu item indicates that items can be selected with the [LEFT]/[RIGHT] CURSOR buttons ②.

The menu of this unit consists of three screens of PAGE 1 to 3.

### ■ MENU-PAGE 1

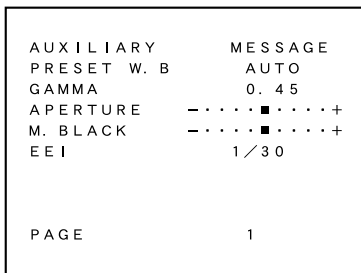

**[AUXILIARY] menu**  
Functions of selected items are described below.

Selected items	Functions
MESSAGE	The message input with MESSAGE EDIT in the [START] menu on MENU-PAGE 3 is shown in the upper left corner of the screen.
GAIN/SHUT	The GAIN value and SHUTTER value are shown in the upper left corner of the screen.
OFF	No indication
W. B. NAME	"AUTO WHITE BALANCE", "MANUAL WHITE BALANCE", "PRESET 3200K", "PRESET 5600K" or the setting made by a technician are shown when the [WHITE BALANCE] switch or the [PRESET W. B.] menu is used.

**[PRESET W. B.] menu**  
Use to select one of the preset white balance settings (3200K, 5600K, or custom setting preset by a technician).  
When the [WHITE BALANCE] switch is set to [PRESET], use the [LEFT]/[RIGHT] button to select 3200K, 5600K, or the custom preset value. Select 3200K or 5600K with the [3200K/5600K] switch.

**[GAMMA] menu**  
Select a gamma correction value or no gamma correction.

Selected items	Gamma
0.45	$\gamma = 0.45$
0.48	$\gamma = 0.48$
OFF	No gamma correction ( $\gamma = 1.0$ )

**[APERTURE] menu**  
Select the contour compensation value or no contour compensation.  
The leftmost setting on the minus side is for no contour compensation. Compensation values are selectable in 8 steps.

**[M. BLACK] menu**  
Select the master black (setup) value.  
4 steps in the  $\pm$  direction (about 2% shift/step) with the center value standing for no setup.

**[EEI] menu**  
Select whether or not to use the 1/30-sec. shutter speed when automatic sensitivity compensation (ALC+EEI) is used.

Selected items	Shutter speeds
1/30	1/30 sec. is used.
1/60	1/30 sec. is not used.

**[PAGE] menu**  
Switch menu PAGE 1 to PAGE 3 with the CURSOR [LEFT]/[RIGHT] buttons.

## ■ MENU-PAGE 2

```

DATE          1998. 11. 30
TIME          00:00:00
DATE FORM    1998. 11. 30
IRIS ZONE    LARGE
IRIS DET.    P.....A
GENLOCK      -.....+

PAGE          2
    
```

### [DATE] menu

Set the date.

Use the [LEFT]/[RIGHT] buttons to select the part of the date to be changed (the numbers will blink). Use the [UP]/[DOWN] buttons to set the new value.

### [TIME] menu

Set the time.

Use the [LEFT]/[RIGHT] buttons to select the part of the time to be changed (the numbers will blink). Use the [UP]/[DOWN] buttons to set the new value.

### [DATE FORM] menu

Change the date display format.

Use the [LEFT]/[RIGHT] buttons to select one of three formats (year, month, day/day, month, year/month, day, year). The date displays change in the following order:

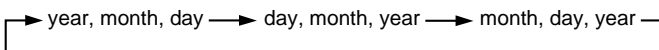

### [IRIS ZONE] menu

Change the size of the zone where automatic sensitivity compensation (ALC, ALC+EEI) is performed.

Select from [LARGE], [MEDIUM], [SMALL] or [V.STRIPE] with the [LEFT]/[RIGHT] buttons.

### [IRIS DET.] menu

Select the level detection method for automatic sensitivity compensation (ALC, ALC+EEI) from peak detection (P), average detection (A) or both. Use the [LEFT]/[RIGHT] buttons to select from 9 different levels. Peak detection is at the far left, while average detection is at the far right. The 7 levels in between can be used for combinations of peak detection and average detection.

### [GENLOCK] menu

Use the [LEFT]/[RIGHT] buttons to adjust the horizontal phase for the external sync signal. Phase can be adjusted in 9 steps. Each time the button is pressed, the phase is shifted by 34 ns. Pressing the button 10 times (340 ns), moves the indication by one graduation. Adjustment up to 2.6 μs is possible.

### [PAGE] menu

Switch menu PAGE 1 to PAGE 3 with the CURSOR [LEFT]/[RIGHT] buttons.

## ■ MENU-PAGE 3

```

MESSAGE EDIT

START
CLEAR

PAGE          3
    
```

Use this menu to edit the message which will be shown in the upper left corner of the screen.

- The message is shown when [MESSAGE] is selected in MENU-PAGE 1's [AUXILIARY] menu.
- The message can include up to 22 alphanumeric characters. Selectable characters include A to Z, 0 to 9, ., :, -, /, and space.

### [START] menu

- ① When [START] is selected, the right arrow (→) and left arrow (←) together with "FIRST" and "LAST" are shown.
- ② The RIGHT/LEFT buttons function as described below.
  - [RIGHT] : The first character of the message can be edited.
  - [LEFT] : The last character of the message can be edited.

- ③ Once you start editing, the buttons function as described below.

[UP]/[DOWN] : Selects the characters.  
[LEFT]/[RIGHT] : Moves the cursor.

### [CLEAR] menu

Use this menu to delete the message. When [CLEAR] is selected, the right arrow (→) and "EXECUTE" are shown.

Press the [RIGHT] button. The down arrow (↓) and "OK", and the up arrow (↑) and "CANCEL" are shown. To delete the message, press the [DOWN] button. To cancel the operation, press the [UP] button. The right arrow (→) and "EXECUTE" indications are restored.

### [PAGE] menu

Switch menu PAGE 1 to PAGE 3 with the CURSOR [LEFT]/[RIGHT] buttons.

# Preparation

## Installing a lens

This unit is not provided with a lens. A special C mount type lens with flange back of 28.0 mm can be used with no adapter. To use a 1/2" bayonet mount type lens, an optional adapter (GL-V62U) is required.

- Consult your lens dealer for information on installing and using your lens.
- Make sure the lens is screwed all the way in. Otherwise, back focus cannot be obtained.

### Reference

For your reference, examples of lenses that can be used with the adapter are listed in the table below.

1/2" bayonet mount type lens

Manufacturer	Lens type
Fujinon	MSF10B MSF75B MS8X12B MSF20B MSF35B

## Installing the camera control unit (when installing in a rack)

The camera control unit is provided with screw holes on its side panels to allow installation in an EIA 19" rack.

1. Remove the screws securing the rubber feet and detach the rubber feet (four positions).
2. Install the inner members for the slide rails on the side panels of this unit.
3. Install the outer members for the slide rails on the rack. Slide the unit into the rack.

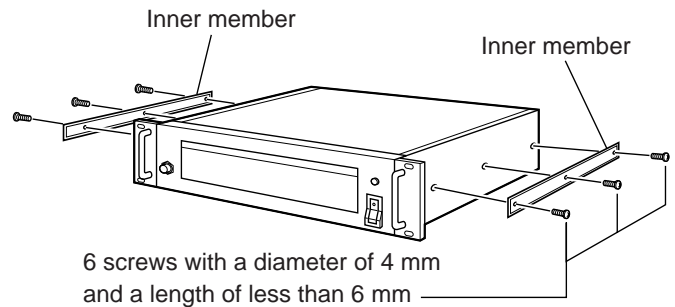

Inner member installation

Slide rails from the following manufacturer can be used.

Model name	Manufacturer's name	Slide length
C-305-20	Japan Acuride Co., Ltd.	508 mm (20')

- For information on the installation of the outer members and rack, consult the slide rail manufacturer or your dealer.

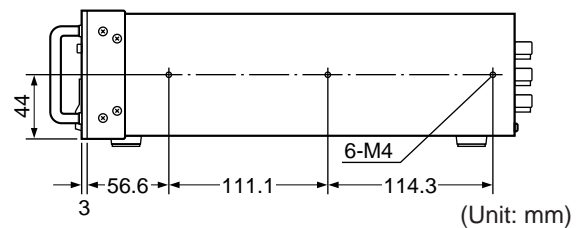

Inner member installation hole position dimensions

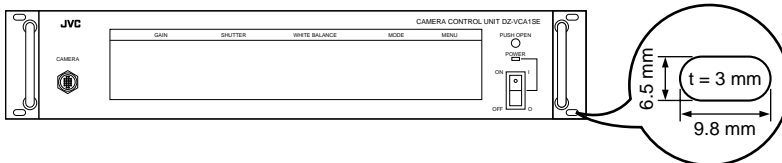

Screw hole size

# Before shooting

## Setting the switches for white balance adjustment

To ensure a clear picture with correct colour tones, the back focus and white balance must be adjusted prior to shooting.

Check your connections before making any adjustments. With a monitor connected, set the camera control unit's switches as shown below.

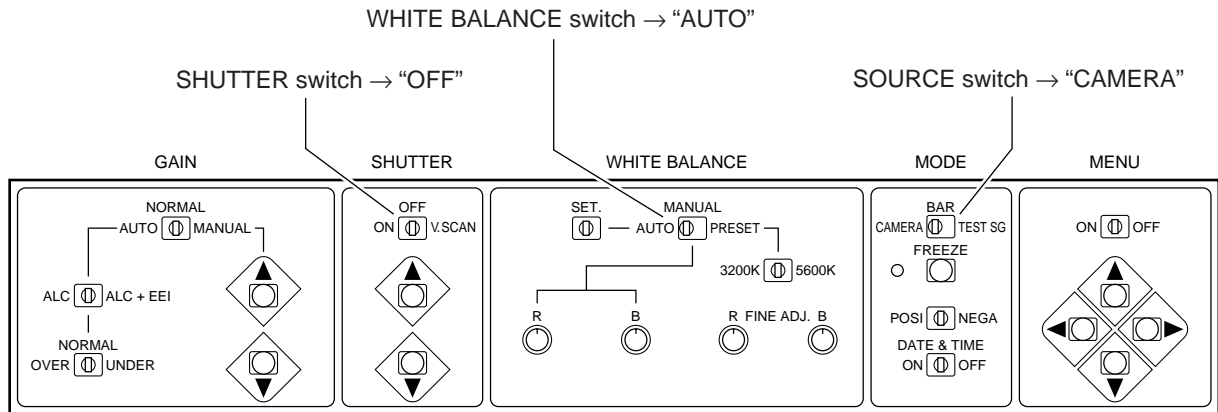

– In the function box –

When setting is complete, shoot a test subject. Adjust the lens focus and check the picture on the monitor.

White balance must be adjusted beforehand each time you shoot.

Be sure to check the colour tone of the monitor using the BAR signal before adjusting white balance.

If the monitor's colour tone is incorrect, it may not be possible to accurately adjust the white balance.

## Back focus adjustment

To adjust the back focus, refer to the instruction manual provided with the lens you are using.

Back focus adjustment is required only when the lens is installed. No further adjustment is necessary.

# Basic operation

## White balance adjustment

While referring to the monitor, shoot a white subject (such as a wall or sheet of paper) in full screen under the same lighting conditions as those that will exist during the actual shoot.

### ① White balance adjustment (auto)

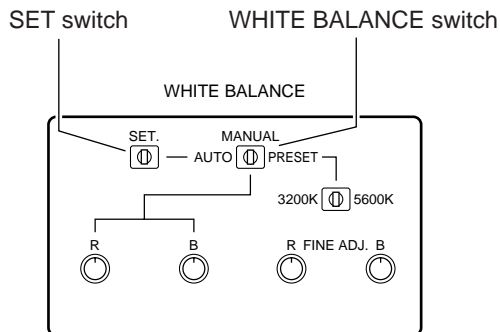

Set the WHITE BALANCE switch to [AUTO]. Hold the [SET] switch to the right. [AUTO WHITE] will blink in the upper left corner of the monitor screen. When white balance adjustment is complete, this indication changes to [AUTO WHITE OK]. For further fine adjustment, use the [ADJ R]/[ADJ B] volume controls for FINE ADJ.

If the indication in the upper left corner of the monitor screen does not change to [AUTO WHITE OK], white balance has not been completely adjusted.

Check the following points, then retry auto white balance adjustment.

1. Is the light insufficient?  
Adjust the lighting.
2. Did you shoot a coloured subject?  
Shoot a white subject.

### ② White balance adjustment (manual)

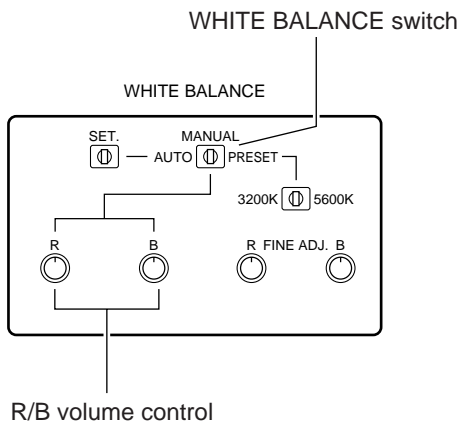

Connect a measuring instrument such as a waveform monitor to the video signal output jacks and adjust the white balance while watching the waveform. First, set the WHITE BALANCE switch to [MANUAL]. Adjust the  $P_B$ ,  $P_R$  output amplitudes to the minimum with the [R]/[B] volume controls. Adjust the  $P_R$  with the [R] volume control and the  $P_B$  with the [B] volume control.

If a measuring instrument is not available, adjust the picture on the monitor screen until it is white. In this case, high-precision white balance cannot be obtained.

### ③ White balance adjustment (preset)

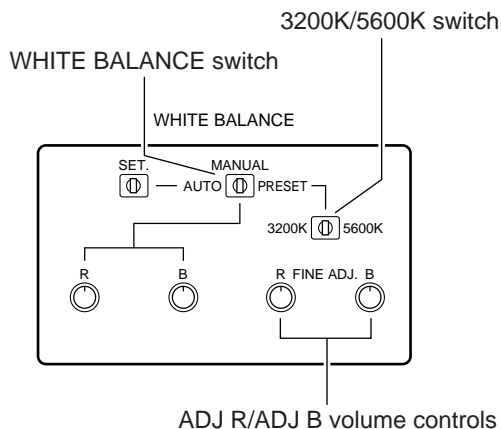

Set the WHITE BALANCE switch to [PRESET]. When a halogen lamp is used as a light source, check the MENU-PAGE 1's [PRESET W.B.] menu, and set the [3200K/5600K] switch to 3200K. If a light source similar to sunlight is used, set this switch to 5600K. For further fine adjustment, use the [ADJ R]/[ADJ B] volume controls for FINE ADJ.

# Connectors

## ① Input/output connector on the camera head

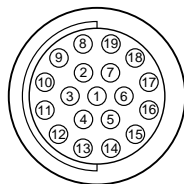

Pin Nos.	Signals	Pin Nos.	Signals
①	Clock output	⑪	Video signal output
②	GND	⑫	GND
③	Control signal input	⑬	Video signal output
④	Control signal input	⑭	GND
⑤	Sync signal input	⑮	15 V input
⑥	Sync signal input	⑯	5 V input
⑦	Video signal output	⑰	GND
⑧	GND	⑱	-8.5 V input
⑨	Video signal output		-5 V input
⑩	GND		

## ② Input/output connector on the CCU

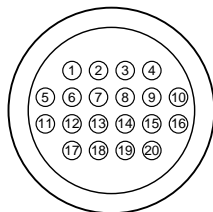

Pin Nos.	Signals	Pin Nos.	Signals
①	Clock input	⑪	Video signal input
②	GND	⑫	GND
③	Control signal output	⑬	Video signal input
④	Control signal output	⑭	GND
⑤	Sync signal output	⑮	15 V output
⑥	Sync signal output	⑯	5 V output
⑦	Video signal input	⑰	GND
⑧	GND	⑱	-8.5 V output
⑨	Video signal input	⑲	-5 V output
⑩	GND	⑳	NC

## ③ DC input connector

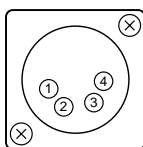

Pin Nos.	Signals
①	GND
②	NC
③	NC
④	+12 V input

# Micro HD camera system component list

## ■ HD camera system

Trade name	Model name	Organization
Micro HD camera	DZ-VCA1SE	Camera head Camera Control Unit Insulating rubber covers x 3 Handle Power code for UK Power code for EC Continent Power code for W-VHS SCSI card SCSI cable Power code for ZIP drive Monitor cable
AC power adapter	AA-V112E	AC power adapter Power code for AC adapter
Isolation transformer	AA-V31E	Isolation transformer, Plug retainer brackets, Cover plates, Torx head screws
Camera cable	VC-V3	Camera cable 3 m
Camera cable	VC-V10	Camera cable 10 m
Microscope adapter	GL-V61U	Microscope adapter
1/2 inch bayonet conversion adapter	GL-V62U	1/2 inch bayonet conversion adapter
Endoscope adapter	GL-V63U	Endoscope adapter
Endoscope zoom adapter	GL-V64U	Endoscope zoom adapter
HD monitor	HV-M2000V	HD monitor, Power code
W-VHS VCR	SR-W7MAE	W-VHS VCR, Power code
Cart	(VS5402.X/VS6300.X)	Cart
ZIP drive	(Z250S)	ZIP drive, AC power adapter for ZIP drive

		Voltage	Current	Frequency
Micro HD camera		DC 12 V	DC 1.3 A	
AC power adapter	in	AC 120 V	AC 0.8 A (max)	50 Hz
	out	DC 12 V	DC 3.0 A	
Isolation transformer	in	AC 230 V	AC 1.5 A	50 Hz
	out	AC 120 V	AC 2.7 A	
HD monitor		AC 120 V	AC 1.6 A	50/60 Hz
W-VHS VCR		AC 110 V – 240 V	AC 0.7 A	50/60 Hz
ZIP drive AC adapter	in	AC 100 V – 240 V	AC 0.2 A	50/60 Hz
	out	DC 5 V	DC 1.0 A	



# Specifications

\* Design and specifications subject to change without notice.

## Camera head section

■ Image sensing device	: 1/3-inch IT-CCD (410,000 pixels)
■ Shooting system	: 4-CCD new dual green system
■ Colour separation optical system	: 1/3 type F1.4 3-colour separation prism
■ Number of effective pixels	: 768 (horizontal) x 494 (vertical), 380,000 pixels
■ Camera output	: 19 pins
■ Lens mount	: Special mount (C mount form, flange back: 28.0 mm)
■ Dimensions	: Camera head; 59 (W) x 70 (H) x 79 (D) mm (2-3/8" x 2-13/16" x 3-1/8") (not including insulating rubber covers)
■ Weight	: Camera head; 230 g (0.51 lbs.) (not including insulating rubber covers)
■ Classification	: Type BF

## Camera control unit section

■ Number of scanning lines	: 1125 (980 effective)
■ Scanning system	: 2:1 interlace
■ Scanning frequency	: 33.75 kHz (horizontal), 60 Hz (vertical)
■ Aspect ratio	: 4:3
■ Horizontal resolution (center)	: More than 800 TV lines (Y signal)
■ Vertical resolution (center)	: More than 650 TV lines (Y signal)
■ S/N	: 52 dB
■ Sensitivity	: F5.6, 2000 lx
■ Minimum subject illuminance	: 10 lx (F1.6 + 12 dB, 1/30 shutter, 50% level)
■ Sync system	: Internal sync/external sync
■ External sync signal input	: Composite video signal of 1 Vp-p or composite sync signal of $\pm 0.3$ Vp-p, 75 ohms, BNC x 1
■ Colour bar	: Full colour bar
■ Contour correction	: Horizontal dual-edged (9-step variable) Vertical dual-edged (9-step variable)
■ Electronic shutter speed	: 1/30 s, 1/60 s (normal), 1/100 s (flicker-free), 1/175 s, 1/250 s, 1/375 s, 1/500 s, 1/1000 s, 1/2000 s
■ Video output	
• R/G/B signal	: 0.7 Vp-p, 75 ohms for each (no sync), BNC connector x 3 (one for each)
• Y/P <sub>B</sub> /P <sub>R</sub>	Y : 1 Vp-p, 75 ohms (including sync) P <sub>B</sub> : 0.7 Vp-p, 75 ohms (including sync) P <sub>R</sub> : 0.7 Vp-p, 75 ohms (including sync)
• Sync signal	: HD; BNC x 1 (TTL) VD, BNC x 1 (TTL) C. SYNC; BNC x 1 ( $\pm 0.3$ Vp-p, 75 ohms, compliant with HDTV standard ITU-R Rec. 709)
■ SCSI Interface	: Half pitch D-sub 50 pin (female) x 2
■ Camera input	: 20 pins
■ Date indication	: Menu system 1) Year, month, day 2) Day, month, year 3) Month, day, year
■ Time indication	: Menu system, hour: minute: second
■ Power supply	: DC 12 V, 1.3 A XLR 4 pins, AA-V112E AC power adaptor When using this unit for medical purposes, be absolutely sure to use the separately sold AA-V31E isolation transformer.
■ Power consumption	: 18 W
■ Operating environment	: +5°C to +35°C (41°F to 95°F), 35 – 75%
■ Allowable storage environment	: -20°C to +50°C (-4°F to 122°F), 35 – 80%
■ Dimensions	: 430 (W) x 93 (H) x 322 (D) mm (16-15/16" x 3-11/16" x 12-11/16") (excluding the handle for rack mounting)
■ Weight	: 4.9 kg (10.8 lbs.)
■ Accessories	: Handle set x 1
■ Supplied documentation	: Instruction manual x 1 Warranty card x 1 Service center information x 1

### AC power adapter AA-V112E

- **Manufacturer** : Victor Company of Japan Limited
- **Input** : AC 120 V 50 Hz, MAX. 0.8 A
- **Output** : 12 V DC 3.0 A
- **Accessories** : AC inlet cable (Hospital Grade) x 1
- **Classification** : Class I

### Isolation transformer AA-V31E

- **Manufacturer** : Victor Company of Japan Limited
- **Classification** : CLASS I
- **Input** : AC 230 V 1.50 A  
50 Hz
- **Output** : AC 120 V 2.7 A  
50 Hz
- **Accessories** : Plug retainer bracket x 4  
Torx head screw x 8  
Cover plate x 4  
Flat washer x 3  
Split locking washer x 3

### HD monitor HV-M2000V

- **Power requirements** : AC 120 V 50/60 Hz
- **Power consumption** : 1.6 A
- **Dimensions** : 476 mm (W) x 407.5 mm (H) x 529 mm (D)
- **Weight:** : 31.6 kg
- **Accessory** : AC power cord (2.4 m) x 1

### W-VHS VCR SR-W7MAE

- **Power requirements** : AC 110 – 240 V 50/60 Hz
- **Dimensions** : 476 mm (W) x 148 mm (H) x 366 mm (D)
- **Weight:** : 10 kg
- **Accessories** : Power cord x 1  
Remote control unit x 1  
Cleaning tape x 1

### Mobile video cart VS5402.X/VS6300.X

- **Dimensions**
- VS5402.X : 500 mm (W) x 1428 mm (H) x 490 mm (D)
- VS6300.X : 600 mm (W) x 1108 mm (H) x 490 mm (D)

#### ■ Load capacity

- Basic-framework total additional load : 225 kg
- Shelf : 50 kg
- Drawer : 20 kg
- Pull-out shelf : 20 kg

#### ■ Monitor shelf

- Load capacity : 35 kg

### Zip drive Z250S

#### ■ AC adapter for ZIP drive

- Input : AC 100 – 240 V  
50/60 Hz
- Output : 5 V DC 1.0 A

## TECHNICAL AND SERVICE ASSISTANCE

JVC offers technical and customer service assistance. Please contact us at the following address.









### JVC PROFESSIONAL PRODUCTS (UK) LIMITED

ULLswater House, Kendel Avenue, London W3 OXA, United Kingdom  
TEL: (0181) 896-6000  
FAX: (0181) 896-6060

### JVC PROFESSIONAL PRODUCTS GmbH

Grüner Weg 10, 61169 Fiedberg/Hessen, Germany  
TEL: (06031) 6050  
FAX: (06031) 605180

**Symbols indicated on this equipment have the following meanings.**

	Attention, consult ACCOMPANYING DOCUMENTS
	Alternating current
	Direct current
	Off (power: disconnection from the mains)
	On (power: connection to the mains)
	TYPE BF APPLIED PART
	Equipotential terminal
	Video output

■ Outer dimensions

Camera head

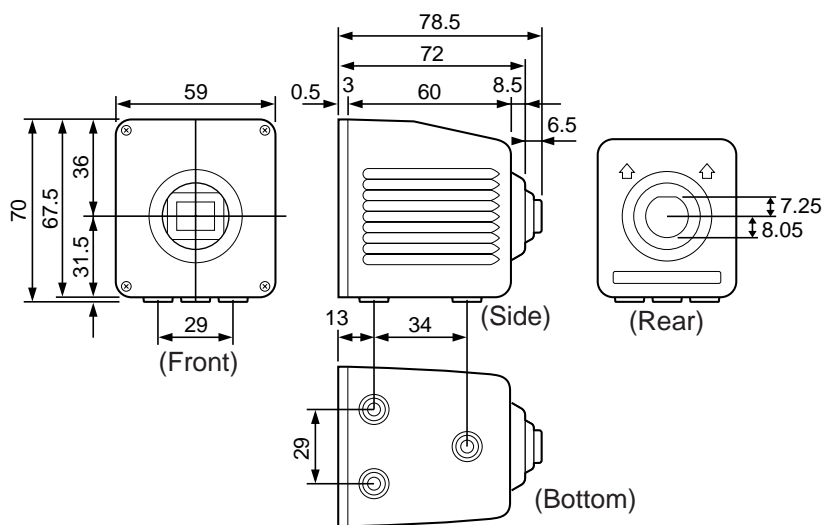

Camera control unit

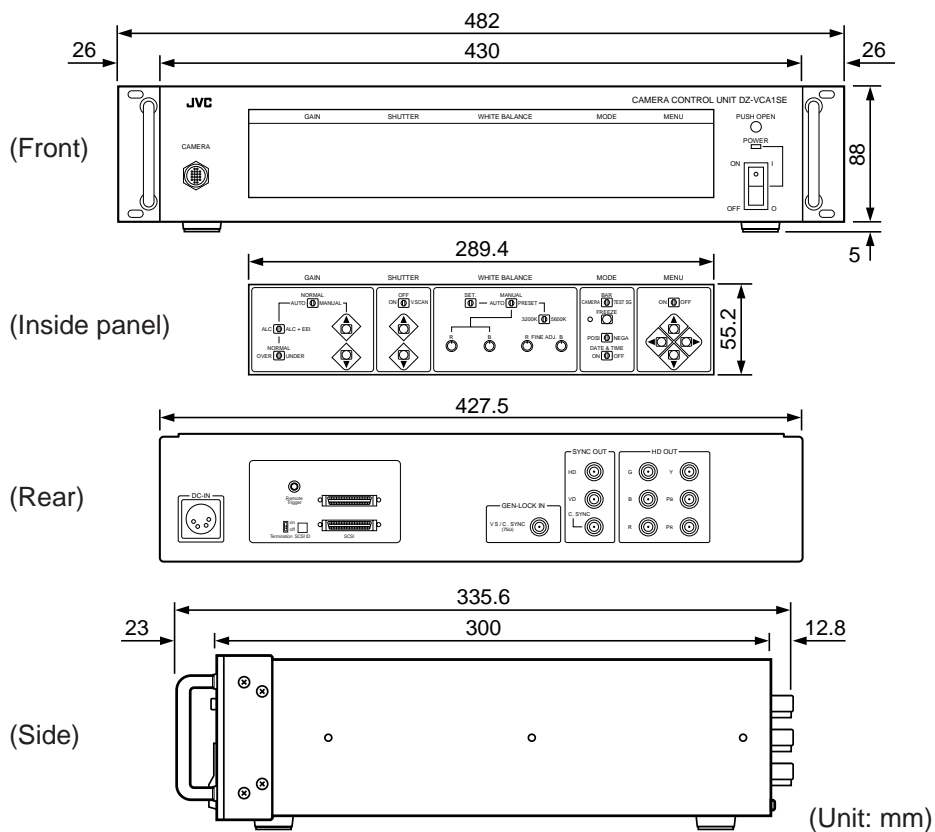

# JVC

**JVC PROFESSIONAL PRODUCTS (UK) LIMITED**

ULLswater House, Kendel Avenue, London W3 OXA, United Kingdom

**JVC PROFESSIONAL PRODUCTS GmbH**

Grüner Weg 10, 61169 Fiedberg/Hessen, Germany

# JVC

## ISOLATION TRANSFORMER

## Instructions

### AA-V31E

### Dear Customer,

Thank you for purchasing the JVC Isolation Transformer AA-V31E. Before use, please read the safety precautions below to ensure safe use of your new Isolation Transformer.

#### For Customer Use:

Enter below the Model No. and Serial No. which are located on the rear of the cabinet. Retain this information for future reference.

Model No. \_\_\_\_\_

Serial No. \_\_\_\_\_

## Safety precautions

#### WARNING:

To prevent fire or shock hazard, DO NOT expose this unit to rain or moisture.

#### WARNING:

To prevent electrical shock, DO NOT remove the Isolation Transformer cover.

#### WARNING:

The Isolation Transformer's "thumb screw" ground-stud is to be used to connect items such as static discharge floor mats or telephone switch grounds that contain a single conductor ground.

Any equipment that is not connected via a 3-conductor power cord will be floating above ground. If the end user elects to provide additional grounds, they *must be* tied to the ground-stud.

#### WARNING:

This equipment is not sterilized.

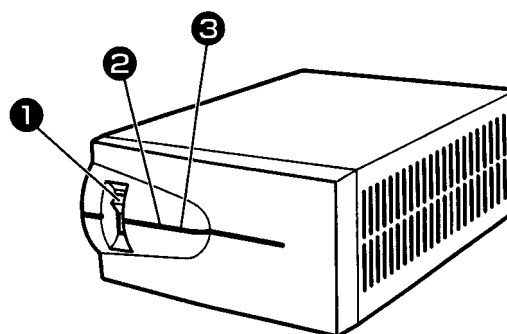

- ① Breaker/power switch
- ② Power lamp (Green LED)
- ③ Ground indicator lamp (Red LED)

## INTRODUCTION

JVC Isolation Transformer AA-V31E is designed to protect electronic microprocessor-based systems from problems caused by power line disturbances.

The model you have purchased is designed for use together with the AC Power Adapter AA-V112E and MICRO HD CAMERA DZ-VCA1SE for medical applications.

## INSPECTION

Remove the Isolation Transformer from the shipping container and inspect it for shipping damage. Do not install or operate the product if it appears to be damaged in any way. If damaged, notify the carrier and seller immediately.

## ENVIRONMENTAL CONSIDERATIONS

This Isolation Transformer has environmental requirements similar to other medical devices. It has been designed for indoor use only, in areas where it will not be exposed to excessive dust or moisture. Make certain that there is adequate air flow around the unit. Do not place objects on top of or near the unit which could obstruct the air vents. For installation, please refer to the MICRO HD CAMERA DZ-VCA1SE Instruction Book.

## SIZING INFORMATION AND INSTALLATION PROCEDURE

The name plate on the rear panel lists the Isolation Transformer voltage and current ratings. Observe that the input current rating is not exceeded when connecting equipment. Ask that installation be performed by a JVC authorized dealer.

## OPERATING INSTRUCTIONS

Turn all load equipment ON.

Turn the Isolation Transformer circuit breaker ON. Observe that the front-panel green LED is illuminated. Observe that the red LED (marked ) is not illuminated (place the Isolation Transformer on a non-grounded surface such as a carpet, wooden table, or magazine for this test).

### CAUTION:







If the red LED is continuously flashing, the wall receptacle (powering the Isolation Transformer) is not connected to the system safety ground. Immediately contact an electrician to correct the wiring discrepancy.

### IMPORTANT NOTE:

The red LED is not intended to test general wiring integrity. Hot-neutral reversal, neutral-ground reversal, and/or other wiring errors will not illuminate the red LED.

Once the Isolation Transformer has been properly installed per the installation instructions, the Isolation Transformer and load equipment can be turned ON/OFF via the Isolation Transformer circuit breaker (and if not externally circuit breaker equipped, via the panel circuit breaker).

**Symbols indicated on this equipment have the following meanings.**

	Attention, consult ACCOMPANYING DOCUMENTS
	Dangerous voltage
	Alternating current
	Off (power: disconnection from the mains)
	On (power: connection to the mains)
	Equipotential terminal

## SPECIFICATIONS

### Isolation Transformer

■ <b>Manufacturer</b>	: Victor Company of Japan Limited
■ <b>Model No.</b>	: AA-V31E
■ <b>Classification</b>	: CLASS I
■ <b>Input</b>	: 230 V AC $\sim$ 1.50 A 50 Hz
■ <b>Output</b>	: 120 V AC $\sim$ 2.7 A 50 Hz

### Accessories

■ <b>Plug retainer bracket</b>	x 4
■ <b>Torx head screw</b>	x 11
■ <b>Cover plate</b>	x 3
■ <b>Flat washer</b>	x 4
■ <b>Split locking washer</b>	x 11
■ <b>Input cord holder</b>	x 1

## TECHNICAL AND SERVICE ASSISTANCE

JVC offers technical and customer service assistance. Please contact us at the following address.

**JVC PROFESSIONAL PRODUCTS (UK) LIMITED**  
 ULLswater House, Kendel Avenue, London W3 OXA,  
 United Kingdom  
 TEL: (0181) 896-6000  
 FAX: (0181) 896-6060

**JVC PROFESSIONAL PRODUCTS GmbH**  
 Grüner Weg 10, 61169 Fiedberg/Hessen, Germany  
 TEL: (06031) 6050  
 FAX: (06031) 605180

# JVC

## AC POWER ADAPTER

## Instructions

### AA-V112E

### Dear Customer,

Thank you for purchasing the JVC AC Power Adapter AA-V112E. Before use, please read the safety precautions below to ensure safe use of your new AC Power Adapter.

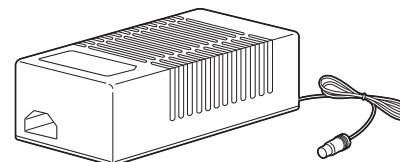

AC Power Adapter

### For Customer Use:

Enter below the Model No. and Serial No. which are located on the bottom of the cabinet. Retain this information for future reference.

Model No. \_\_\_\_\_

Serial No. \_\_\_\_\_

## Safety precautions

### WARNING:

To prevent fire or shock hazard, DO NOT expose this equipment to rain or moisture.

### WARNING:

This equipment is not sterilized.

### INTRODUCTION

The model you have purchased is designed for use together with the Isolation Transformer AA-V31E and MICRO HD CAMERA DZ-VCA1SE for medical applications.

### INSPECTION

Remove the AC Power Adapter from the shipping container and inspect it for shipping damage. Do not use the product if it appears to be damaged in any way. If damaged, notify the carrier and seller immediately.

### ENVIRONMENTAL CONSIDERATIONS

This AC Power Adapter has environmental requirements similar to other medical devices. It has been designed for indoor use only, in areas where it will not be exposed to excessive dust or moisture. Make certain that there is adequate air flow around the unit. Do not place objects on top of or near the unit which could obstruct the air vents. For usage, please refer to the MICRO HD CAMERA DZ-VCA1SE Instruction Book.

### SIZING INFORMATION AND INSTALLATION PROCEDURE

The name plate on the top panel lists the AC Power Adapter voltage and current ratings. Observe that the input current rating is not exceeded when connecting equipment. Ask that installation be performed by a JVC authorized dealer.



## AA-V112E INFORMATION

This information contains instructions on using AA-V112E. Please read it to use properly.

### The way of use and instructions

- AA-V112E is inlet type AC power adapter. For the input cord, be sure to use the provided AC inlet cable.
- Rated input voltage is AC120V continuously.
- Inside this AC Power Adapter, there is a high voltage part. Never disassemble this.

Symbols indicated on this equipment have the following meanings.

	Attention, consult ACCOMPANYING DOCUMENTS
	Alternating current
	Direct current

## SPECIFICATIONS

### AC Power Adapter

- **Manufacturer** : Victor Company of Japan Limited
- **Model No.** : AA-V112E
- **Input** : AC 120 V  $\sim$  50 Hz  
MAX. 0.8 A
- **Output** : 12 V DC  $\text{---}$  3.0 A

## TECHNICAL AND SERVICE ASSISTANCE

JVC offers technical and customer service assistance. Please contact us at the following address.

**JVC PROFESSIONAL PRODUCTS (UK) LIMITED**  
ULLswater House, Kendel Avenue, London W3 OXA,  
United Kingdom  
TEL: (0181) 896-6000  
FAX: (0181) 896-6060

**JVC PROFESSIONAL PRODUCTS GmbH**  
Grüner Weg 10, 61169 Fiedberg/Hessen, Germany  
TEL: (06031) 6050  
FAX: (06031) 605180



## When connecting camera to an endoscope

- 1) Before using the endoscope, always be sure to sterilize the endoscope video adapter, the camera head, the camera cable, and covers.
- 2) When using the endoscope, always be sure to assemble covers according to the instruction of the left side of this sheet.

### How to assemble covers

1. Turn the front part of endscope adapter counterclockwise and take off them.



2. Insert cover(1) and assemble them.



3. Insert the camera cable connector of the camera head side to cover(2) and assemble them.



4. Insert the camera cable connector of CCU side to cover(3) and assemble them.

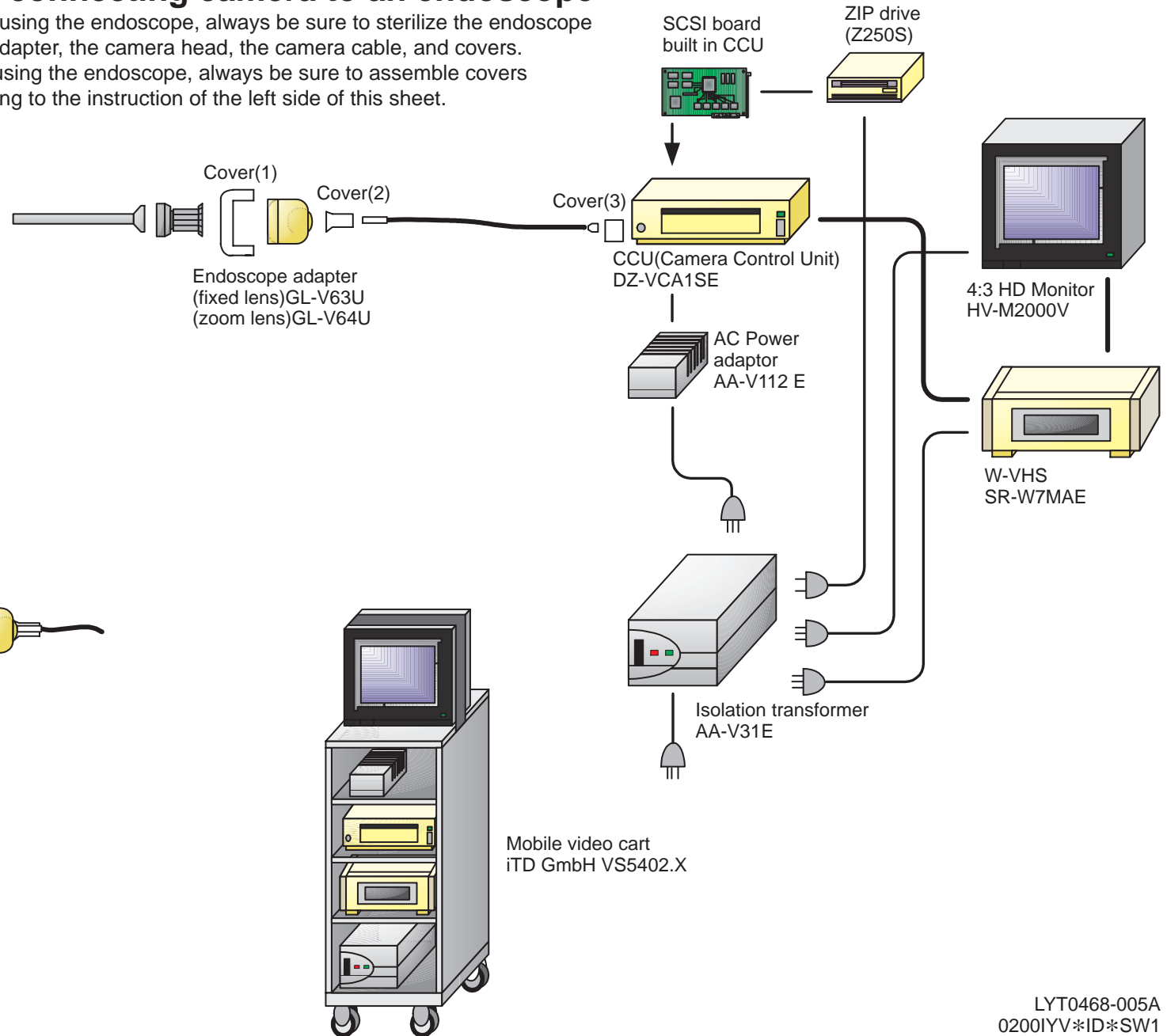



# System Operating Procedure

Check the operation of the system according to the procedure described below.

1. Connect the camera cable to the CCU.
  - Turn off the CCU before connecting or disconnecting the camera cable.
2. Plug the power cord of the Isolation Transformer into a power outlet.
3. Turn on the Isolation Transformer.
  - Confirm that the red LED is not flashing.
  - If the red LED is flashing, do not use the unit. Improve the grounding of the power outlet.
4. Turn on the ZIP drive.
5. After the ZIP drive power stabilizes (about five seconds), turn on the CCU.
  - If the CCU is turned on before the ZIP drive power stabilizes, a communications error may be generated.
  - Load a ZIP disk into the ZIP drive, press the FREEZE button on the CCU's front panel, and confirm that still images are loaded properly.
  - If the green LED on the ZIP drive lights, the unit is operating normally.
6. Turn on the W-VHS unit.
  - Load a W-VHS tape into the unit and confirm that the unit is able to record.
7. Turn on the monitor.
  - Confirm that the MODE selector on the CCU's front panel is set to "CAMERA" and confirm that the image that is being shot by the camera appears on the monitor.
8. Operate each component in accordance with their operating procedures.

**Note:** Connections should be made only by JVC service personnel or other qualified service personnel. Do not disconnect or alter any connections.

# Instruction Booklet

of

## GV-SCS1J

(Hardware)

GV-SCS1J

Instruction Book

# Names and each function for items

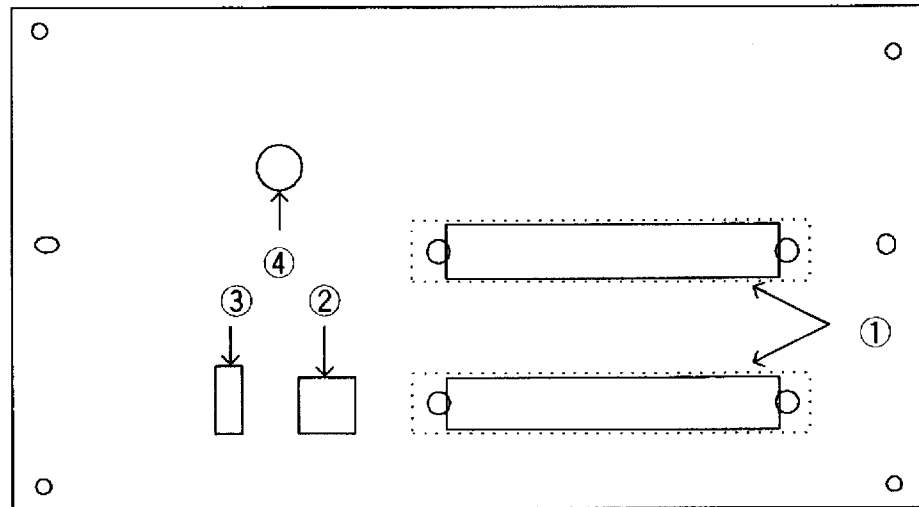

- ① SCSI connector  
connectors for SCSI card and SCSI equipments.  
50-pin high-density.
- ② SCSI ID number SW  
Setting SCSI ID number of capture PWB.  
Note: Set number 7 when recording directly to Zip.  
Recording can not made except number 7.
- ③ SCSI termination SW  
On/Off SW for SCSI termination.
- ④ Connector for capturing SW  
Capture camera image using external trigger SW.  
φ 3.5 audio mini plug connector.

# Hardware setting

Preparation for connecting and setting to capture PWB.

- When connecting this system to computer, SCSI board or SCSI port in PC is required.
- When recording Zip drive directly without PC, Zip drive should work with SCSI.



Caution

## 2. Connection with P C

2-1 Only capture board without any SCSI equipment

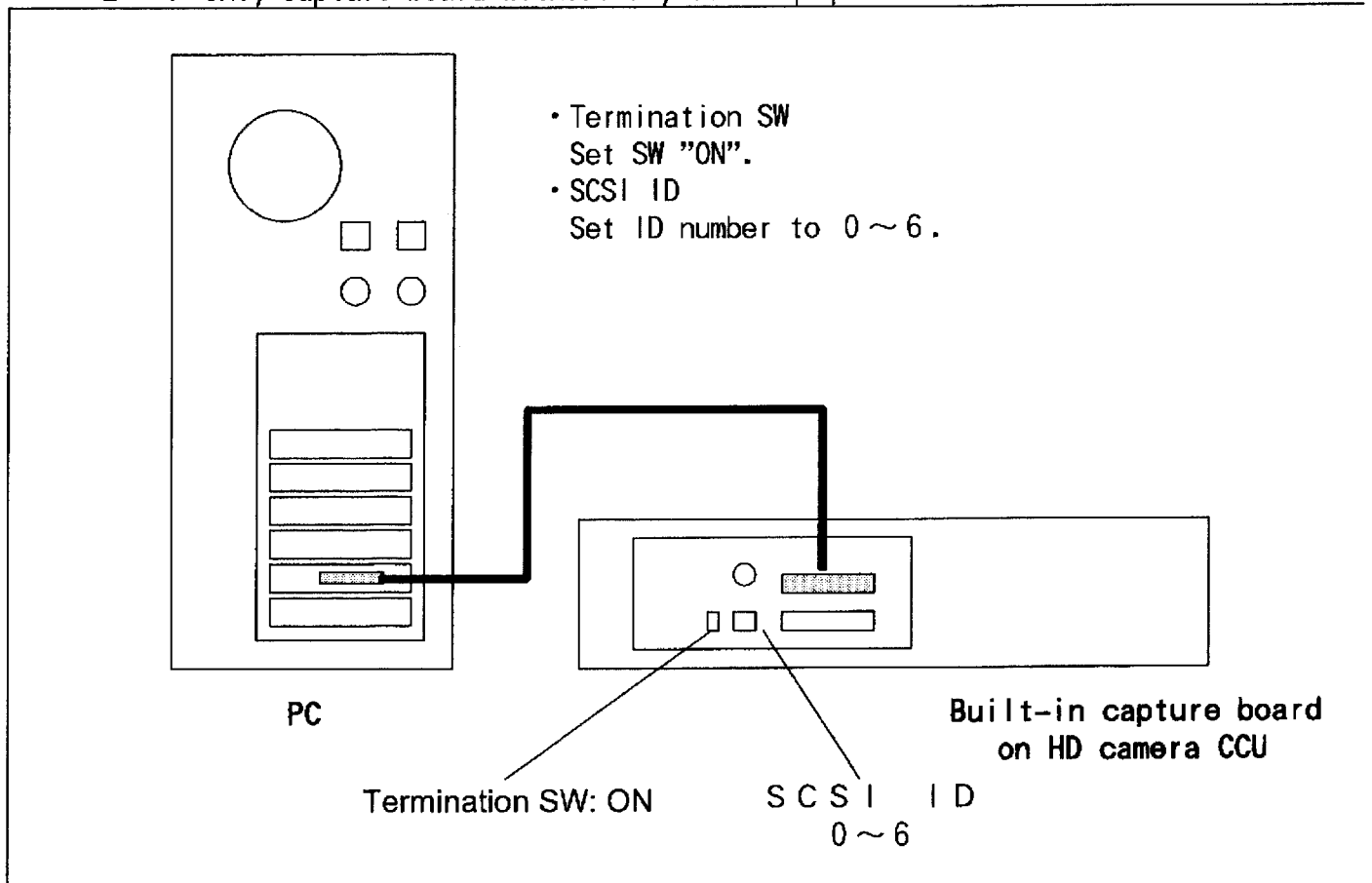

2-2 Capture board and other SCSI equipment

2-2-1 Capture board is last connection of system.

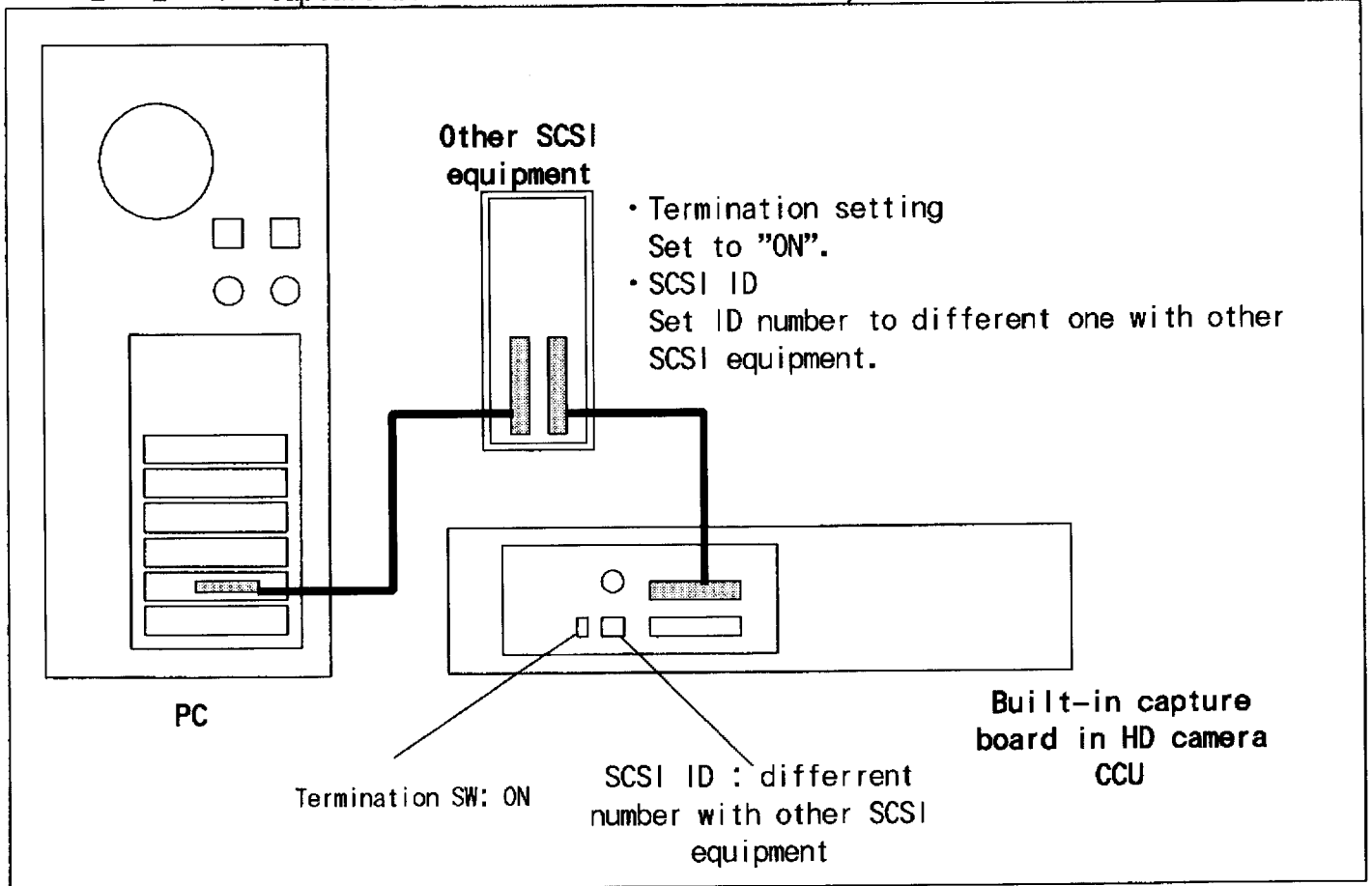

2-2-2 Capture board between PC and other SCSI equipment

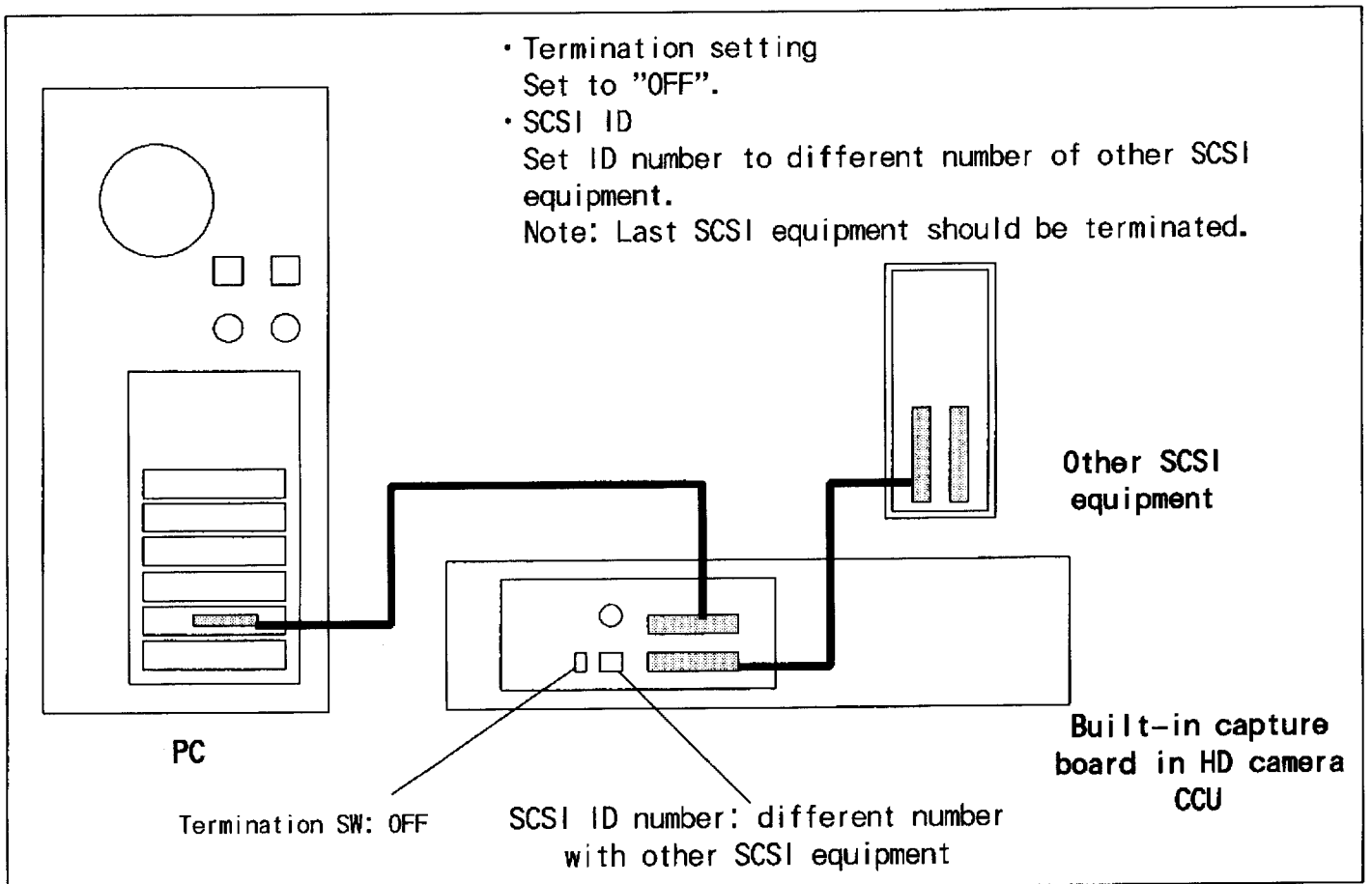

### 3. Direct recording to Zip

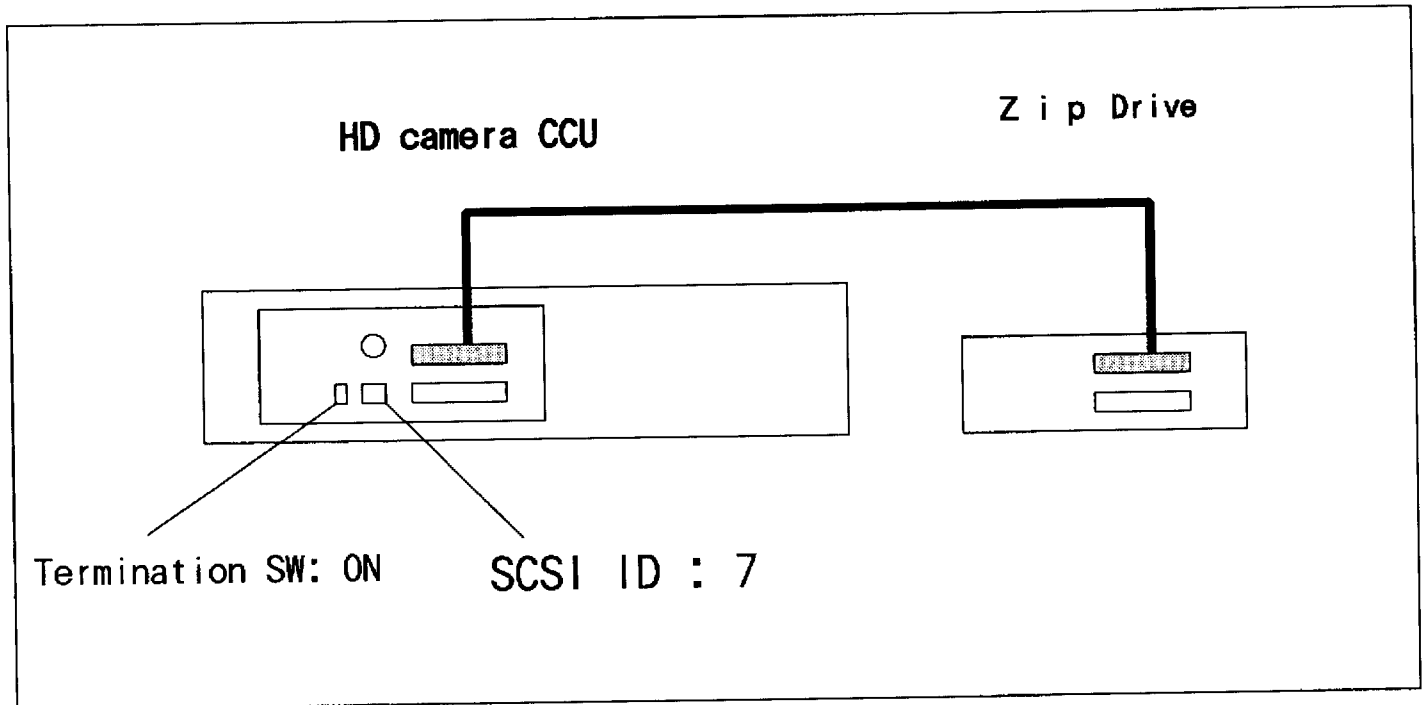

#### Capture board setting

- Termination : ON
- SCSI ID  
Set to 7.

#### Zip setting

- Termination setting  
Set to ON. If termination SW is not available, use termination adapter.
- SCSI ID  
Set to other number except 7.  
Please refer to the instruction book of Zip drive.

Note: This SCSI board can connect to only one Zip.  
Do not connect to plural Zips because it may cause problems.



#### 4 . S C S I cable connection

When connecting SCSI cable, please set power SW off and also insert connector firmly to confirm to hear the click sound.

Two SCSI connectors are available. Both connectors are connected insides. Each one can be used.

#### 5 .Capture SW

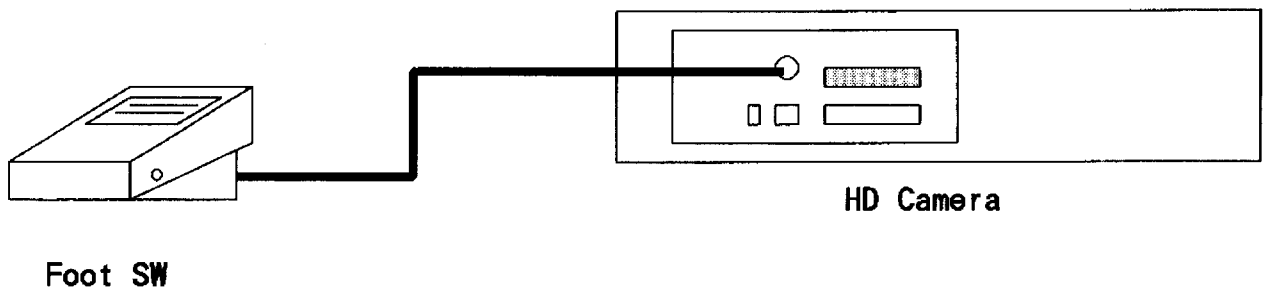

Foot SW for capturing images can be connected to remote trigger connector of HD camera .

Note: The cable length of foot SW should be within 3 meters.  
The connector should be  $\phi$  3.5 audio mini plug.

## Capturing images

### 1. Use with PC

Capture HD camera images with PC.

Note: Please use Adaptec SCSI board.

( Other SCSI boards may not work.)

There are two ways to capture images as follows.

- ① In the case of using attached disc, HDC Capture for Windows.  
Install attached disc, Micro HDC Capture for Windows.  
Captured images can be saved as BMP form.

Please refer to the instructionbook of the softwear.

- ② In the case of using TWAIN32.  
It can be captured by using the application softwear like "Paint shop pro"  
that has the interface with TWAIN32.  
Install TWAIN32 driver of attached disc.  
Please refer to the instructionbook of applicable softwear.  
The extention file is different with the softwear.

### 2. Direct recoding (without PC)

This capture board can dorectly record HD camera images to Zip without PC.

In this case, do not connect with PC otherwise no direct recording can not made.

SCSI ID of HD camera CCU must be set to number 7.

Recorded file form is ".hdc" as a original form.

When opening recorded HDC file, use Micro HDC Capture for Windows.

- How to capture images

Use external trigger SW or [FREEZ] SW on the front panel of CCU.

- How to eject Zip media

Besides of Eject button of Zip drive, eject can be made by keeping to press external trigger SW.

- When Zip media is fully recorded.

When Zip media is fully recorded, Zip media is automatically ejected.

A Zip media can save about 66 HDC images. (A HDC image needs 1.5MB.)

- Zip

250MB and 100MB Zip media can be used.